

MAX-M5Q

Concurrent GNSS Receiver

Data Sheet

Highlights:

- Multi-GNSS engine for concurrent GPS, GLONASS, Galileo and QZSS
- Extremely small form factor and low power consumption
- Self-Assistance for 3 days
- Superior Sensitivity
- Form-factor compatible with MAX-7 series



Document Information

Title	MAX-M5Q
Subtitle	Concurrent GNSS Receiver
Document type	Data Sheet
Document number	UBX-130024951
Document revision	R04
Document status	Early Production Information

Document status information

Objective Specification	This document contains target values. Revised and supplementary data will be published later.
Advance Information	This document contains data based on early testing. Revised and supplementary data will be published later.
Early Production Information	This document contains data from product verification. Revised and supplementary data may be published later.
Production Information	This document contains the final product specification.

This document applies to the following products:

Name	Type number	ROM/FLASH version	PCN reference
MAX-M5Q	MAX-M5Q-0-00	FLASH FW320H-UBX.3163	N/A

This document and the use of any information contained therein, is subject to the acceptance of the u-blox terms and conditions. They can be downloaded from www.u-blox.com.

u-blox makes no warranties based on the accuracy or completeness of the contents of this document and reserves the right to make changes to specifications and product descriptions at any time without notice. Reproduction, use or disclosure to third parties without express permission is strictly prohibited. Copyright © 2013, u-blox AG.

u-blox® is a registered trademark of u-blox Holding AG in the EU and other countries. Easy™ and AlwaysLocate™ are registered trademarks of MediaTek Inc. ARM® is the registered trademark of ARM Limited in the EU and other countries.



Contents

Contents.....	3
1 Functional description.....	5
1.1 Overview	5
1.2 Product features	5
1.3 GNSS performance	6
1.4 Block diagram.....	7
1.5 GNSS.....	7
1.5.1 GPS.....	7
1.5.2 GLONASS.....	7
1.5.3 QZSS	7
1.6 Augmented GPS.....	8
1.6.1 Autonomous A-GPS	8
1.6.2 Satellite-Based Augmentation System (SBAS).....	8
1.7 Logger LOCUS usage	8
1.8 TIMEPULSE	8
1.9 Protocol.....	8
1.10 Interfaces.....	8
1.10.1 UART.....	9
1.11 Clock generation	9
1.11.1 Oscillators.....	9
1.11.2 Real-Time Clock (RTC)	9
1.12 Power management operating modes	9
1.12.1 Continuous mode	9
1.12.2 Power Save mode.....	10
1.12.3 Backup State	11
1.13 Jamming Remover	11
1.14 Antenna.....	11
1.14.1 Antenna input.....	11
1.14.2 Active GNSS antenna	11
1.14.3 Active antenna control (ANT_ON).....	12
2 Pin definition	13
2.1 Pin assignment	13
3 Configuration management	14
4 Electrical specification.....	15
4.1 Absolute maximum rating	15
4.2 Operating conditions	15
4.3 Indicative power requirements.....	16
5 Mechanical specifications	17

6	Reliability tests and approvals	18
6.1	Reliability tests	18
6.2	Approvals	18
7	Product handling & soldering.....	19
7.1	Packaging.....	19
7.1.1	Reels	19
7.1.2	Tapes	19
7.2	Shipment, storage and handling	20
7.2.1	Moisture Sensitivity Levels	20
7.2.2	Reflow soldering	20
7.2.3	ESD handling precautions.....	21
8	Default messages	22
9	Labeling and ordering information.....	23
9.1	Product labeling.....	23
9.2	Explanation of codes.....	23
9.3	Ordering codes	23
	Related documents.....	24
	Revision history	24
	Contact.....	25

1 Functional description

1.1 Overview

MAX-M5Q is a standalone GNSS module from u-blox that supports concurrent GNSS navigation based on the MT3333 chip. With the exceptional utilization of GPS and GLONASS simultaneously, MAX-M5Q can enhance the position availability in harsh GNSS satellite visibility conditions or at high latitudes, e.g. in polar regions.

The Max-M5Q is characterized by a small foot-print, low power consumption, and sophisticated interference suppression, ensuring maximum performance even in GPS-hostile environments. This makes incorporating MAX-M5Q into customer designs simple and straightforward. MAX-M5Q targets industrial and consumer applications that require concurrent GPS/GLONASS reception. MAX-M5Q is form factor compatible with MAX modules, allowing the upgrade of existing designs with minimal effort.

The MAX-M5Q supports a feature called AlwaysLocate™, which is an intelligent controller of the power saving mode. Depending on the environment and motion conditions, the module can adaptively adjust the navigation activity and fix rate based on measured velocity in order to achieve a balance in positioning accuracy, fix rate and power consumption.

The MAX-M5Q supports autonomous A-GPS. Thanks to the EASY™ (Embedded Assist System) ephemeris extension embedded in the software, this is a self-assisted module, with no resources required from the host. It allows a reduction of the warm start TTFF by as much as 90%. The EASY™ data is stored on internal flash memory and allows fast TTFF of typically 3 seconds over 3 days.

The MAX-M5Q also contains an interference suppression, which provides state-of-art narrow band (CW) interference and jamming elimination up to 12 CW jammers < -80 dBm.

The module also supports a logging feature called LOCUS, which enables automatic logging of position data to internal flash memory. The logging capacity is typically >16 hrs @ 15 sec storage interval.

MAX-M5Q modules are manufactured in ISO/TS 16949 certified sites.

1.2 Product features

Model	Type	Supply	Interfaces	Features
	GPS / QZSS GLONASS Galileo BeiDou Timing Dead Reckoning Precise Point Positioning	1.65 V – 3.6 V 2.7 V – 3.6 V 3.0 V – 3.6 V	UART USB SPI DDC (I ² C compliant)	Programmable (Flash) Data logging Extra front-end LNA Front-end SAW filter RTC crystal Internal oscillator Antenna supply Antenna short circuit detection / protection Antenna open circuit detection pin Timepulse output External interrupt / Wakeup
MAX-7C	• •	•	• •	■ C ○ ○ ○ • •
MAX-7Q	• •	•	• •	• T ○ ○ ○ • •
MAX-7W	• •	•	• •	• T • • ○ • •
MAX-M5Q	• •	•	•	• • • • T ○ ○ ○ •

○ = Optional, not activated per default or requires external components

C = Crystal / T = TCXO

■ = Derived from single crystal feature

1.3 GNSS performance

Parameter	Specification	
Receiver type	99/33 (search/track) GNSS L1 C/A-code SPS of GPS + GLONASS, Galileo or Beidou SBAS L1 C/A QZSS L1 C/A	
Chipset	MediaTek MT3333	
Time-To-First-Fix	Cold Start	23 s
	Aided Starts ¹	3 s
	Hot Start	1 s
Sensitivity ²	Tracking & Navigation	-165 dBm typ. (GPS)
	Reacquisition	-160 dBm
	Cold Start	-148 dBm
	Warm Start	-148 dBm
	Hot Start	-156 dBm
Position accuracy ³	Horizontal	3.5 m (67%) typ.
	Vertical	5.0 m (67%) typ.
	SBAS	3.5 m (67%) typ.
Accuracy of time pulse signal	1 μ s (typ.)	
Frequency of time pulse signal	1 Hz	
Max navigation update rate	10 Hz	
Velocity accuracy ⁴	0.1 m/s (50%) typ.	
Operational limits	Altitude	60,000 ft
	Velocity	1,000 knots

Table 1: MAX-M5Q GNSS performance

¹ Dependent on aiding data connection speed and latency

² Measured with external LNA or active antenna NF < 1 dB, G > 15 dB, GPS signals, static condition

³ With nominal GNSS signal levels -130 dBm.

⁴ 50% @ 30 m/s

1.4 Block diagram

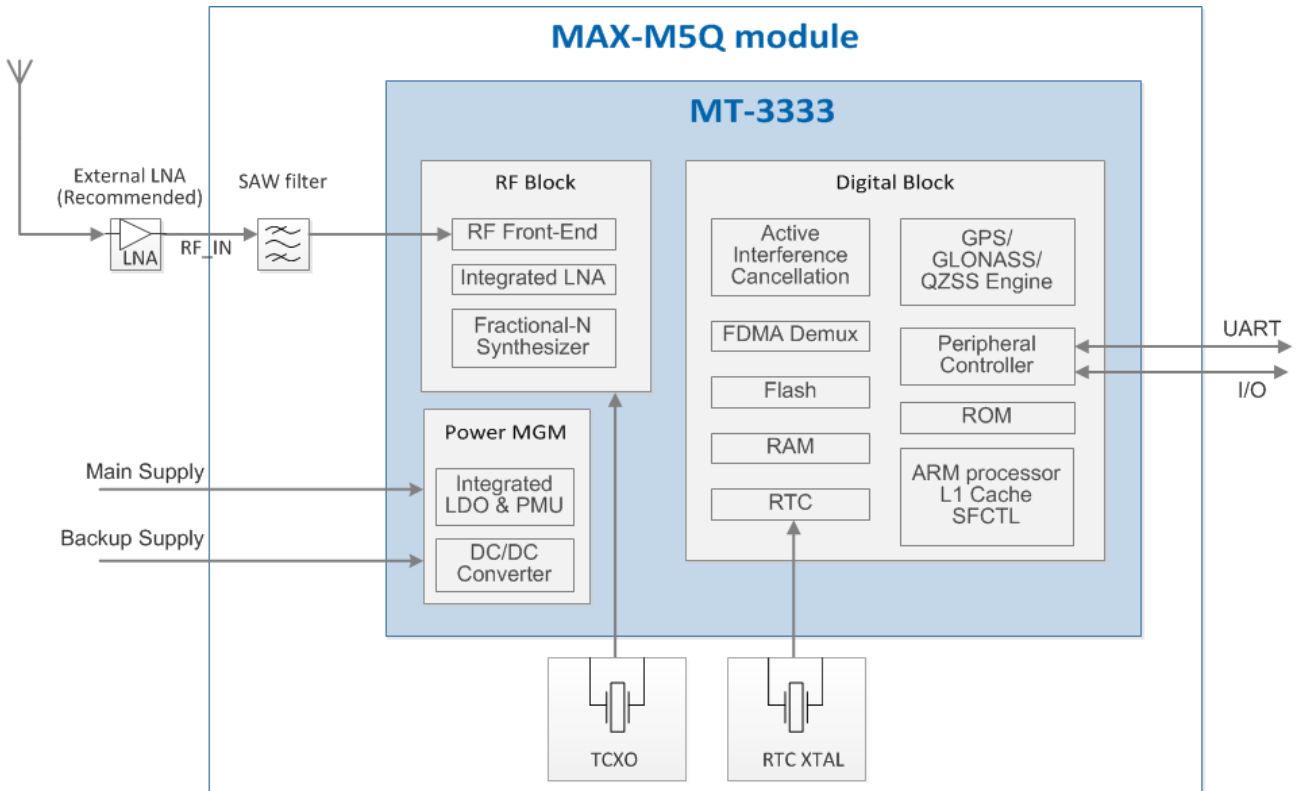

Figure 1: MAX-M5Q block diagram

1.5 GNSS

u-blox MAX-M5Q positioning modules are Multi-GNSS receivers. MAX-M5Q modules can use signals from GPS, GLONASS, and QZSS systems simultaneously. Future firmware upgrades will include future GNSS systems, such as Galileo or Beidou, in GPS + Galileo or GPS + Beidou modes.

1.5.1 GPS

u-blox MAX-M5Q receivers are designed to receive and track the L1 C/A signals provided at 1575.42 MHz by the Global Positioning System (GPS).

1.5.2 GLONASS

The Russian GLONASS satellite system is an alternative system to the US-based Global Positioning System (GPS). The u-blox MAX-M5Q module is capable of receiving and processing GLONASS L1 OF satellite signals using the same hardware.

MAX-M5Q is a multi-GNSS receiver; it can receive and track GLONASS and GPS signals simultaneously.

1.5.3 QZSS

The Quasi-Zenith Satellite System (QZSS) is a navigation satellite overlay system for the Pacific region covering Japan and Australia that transmits additional GPS L1 C/A signals. u-blox MAX-M5Q positioning modules are able to receive and to track these signals simultaneously with GPS and GLONASS, resulting in better availability, especially under bad signal conditions (e.g. in urban canyons).

1.6 Augmented GPS

1.6.1 Autonomous A-GPS

Self-Assistance EASY™ usage

The MAX-M5Q module uses self-assistance EASY™ (Embedded Assist System) GPS satellite ephemeris extension, which is embedded in the software and does not require any resources from the host. The EASY™ data is stored on internal flash memory. EASY™, which is enabled by default, provides a fast TTFF of typically 3 seconds over 3 days.

Allow the receiver to navigate for at least 5 minutes after initial start and after every three days with good GNSS satellite visibility in order to collect broadcast ephemeris and to process necessary information.



For more details see the *MAX-M5Q Receiver Description including Protocol Specification* [1].

1.6.2 Satellite-Based Augmentation System (SBAS)

u-blox MAX-M5Q positioning modules support SBAS. These systems supplement GPS data with additional regional or wide area GPS augmentation data. An SBAS broadcasts augmentation data via satellite that can be used by GPS receivers to improve the resulting GPS precision. SBAS satellites can be used as additional satellites for ranging (navigation), further enhancing precision. The following SBAS are supported with u-blox MAX-M5Q: WAAS, EGNOS, MSAS, GAGAN. SBAS support is enabled by default. For information about the command to disable SBAS functionality, refer to *MAX-M5Q Receiver Description including Protocol Specification* [1].

1.7 Logger LOCUS usage

The MAX-M5Q module supports an embedded logger function called LOCUS, and when enabled it can log position information to internal flash memory. The default log interval is 15 seconds, which provides typically > 16 h log capacity. The LOCUS can be enabled by the command \$PMTK185,0*22.



For more details see the *MAX-M5Q Receiver Description including Protocol Specification* [1].

1.8 TIMEPULSE

The TIMEPULSE (PPS) output signal provides a pulse-per-second output signal for timing purposes. The MAX-M5Q time pulse signal is one pulse per second. Pulse length (high state) is 100 ms and it has 1 μs accuracy synchronized at rising edge to full UTC second with nominal GNSS signal levels. The module will output the PPS signal a few seconds after the first fix and after the fix epoch is synchronized to a full second.

The PPS output is valid when navigation is valid and will also continue to 'freewheel' after a valid fix is lost by a certain navigation DR timeout of typically 10 seconds. Users can also enable the NMEA \$GPZDA message that is sent right after the PPS pulse is sent.



For more details see the *MAX-M5Q Receiver Description including Protocol Specification* [1].

1.9 Protocol

Protocol	Type
NMEA	NMEA-0183 rev. 3.01 Proprietary \$PMTK messages

Table 2: Protocol for MAX-M5Q



For protocol specification see the *MAX-M5Q Receiver Description including Protocol Specification* [1].

1.10 Interfaces

A number of interfaces are provided for data communication or memory access. The embedded firmware uses these interfaces according to their respective protocol specifications.

1.10.1 UART

MAX-M5Q modules include a UART interface, which can be used for communication to a host. It supports configurable baud rates.

The UART Port is normally used for GNSS data reports and receiver control. Serial data rates are configurable from 4,800 baud to 921,600 baud by using the \$PMTK251,<baud>*<checksum><CR><LF> command. Ensure that the message payload fits in the selected baud rate. The default baud rate is 115,200 baud; protocol is NMEA. The RX signal is pulled up internally and can be left floating (not connected) when not used.



Figure 2: UART timing

 For more details see the *MAX-M5Q Receiver Description including Protocol Specification* [1].

1.11 Clock generation

1.11.1 Oscillators

The MAX-M5Q uses a TCXO (26 MHz Master Clock) oscillator. The TCXO allows accelerated weak signal acquisition, enabling faster start and reacquisition times.

1.11.2 Real-Time Clock (RTC)

The RTC is driven by a 32.768 kHz oscillator, which makes use of an internal RTC crystal. If the main supply voltage fails and a battery is connected to V_BCKP, parts of the receiver switch off, but the RTC still runs and provides a timing reference for the receiver. This operating mode is called Backup State, which enables all relevant data to be saved in the backup RAM to allow a hot or warm start later.

1.12 Power management operating modes

u-blox MAX-M5Q technology offers a power-optimized architecture with built-in autonomous power saving functions to minimize power consumption at any given time. The receiver can be used in two operating modes: Continuous mode for best performance or Power Save mode for optimized power consumption. In addition, a high efficiency DC/DC converter is integrated to allow low power consumption even for higher main supply voltages.

MAX-M5Q modules have the following operating modes:

- Continuous mode for best GPS/GNSS performance
- Power Save mode to optimize power consumption
 - Standby mode
 - Periodic mode
 - AlwaysLocate™ mode
- Backup state

1.12.1 Continuous mode

Continuous mode uses the acquisition engine at full performance resulting in the shortest possible TTFF and the highest sensitivity. It searches for all possible satellites until the almanac is completely downloaded. The receiver then switches to the tracking engine to lower the power consumption.

Thus, a lower tracking current consumption level will be achieved when:

- A valid GPS/GNSS position is obtained

- The entire almanac has been downloaded
- The ephemeris for each satellite in view is valid

1.12.2 Power Save mode

For power sensitive applications, the MAX-M5Q module also supports low-power operating modes for reduced power consumption by using the embedded power switch.

For more information about power management command, see the *MAX-M5Q Receiver Description including Protocol Specification* [1].

1.12.2.1 Standby mode

In this mode the receiver stops navigation, the internal processor enters standby state, and the current drain at main supply VCC is typically reduced to 0.4 mA. Standby mode is entered by a PMTK command. The host can wake up the module from Standby mode to Full Power mode by sending any byte via the host port.

For more information about Standby mode command, see the *MAX-M5Q Receiver Description including Protocol Specification* [1].

1.12.2.2 Periodic mode

This mode allows autonomous power on/off with reduced fix rate to reduce average power consumption, as shown in Figure 3 below. The main power supply VCC is still active, but turning the supply on and off is controlled internally by PMTK commands.

For more information about Periodic mode command, see the *MAX-M5Q Receiver Description including Protocol Specification* [1].

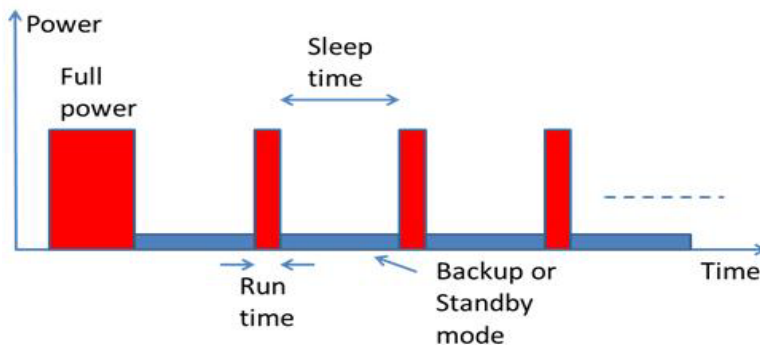

Figure 3: Periodic mode

1.12.2.3 AlwaysLocate mode

AlwaysLocate™ is an intelligent controller of the Periodic mode; the main power supply VCC is still active, but supply is controlled internally by PMTK commands. Depending on the environment and motion conditions, the module can autonomously and adaptively adjust the parameters of the Periodic mode, e.g. on/off ratio and fix rate to achieve a balance in positioning accuracy and power consumption. The average power drain can vary based on conditions; typical average power is 7 mW. Associated profiles are: High and Low Speed, Walking, Outdoor Static and Indoor.

The module can control the embedded VCC power switch autonomously only after the MAX-M5Q is set to Periodic or to AlwaysLocate™ mode by a PMTK command.

Note that first fix position accuracy can be somewhat degraded in Power Management modes when compared to Full Power operation. The user can improve the position accuracy by taking the 2nd or 3rd fix after waking up.

The user can exit low power modes to Full Power by sending a PMTK command just after the module wakes up from its previous sleep cycle.

 For more information about power management command concerning AlwaysLocate mode, see the *MAX-M5Q Receiver Description including Protocol Specification* [1].

1.12.3 Backup State

Backup State means a low quiescent (typically 10 μ A at V_BCKP) power state where receiver operation is stopped; only the backup supply V_BCKP is powered on while the main supply VCC is switched off by the host (or autonomously by MAX-M5Q in Periodic mode and AlwaysLocate™ mode). Waking up from Backup State to Full Power is controlled by the host by switching on the VCC supply.

After waking up, the receiver uses all internal aiding, including GNSS time, Ephemeris, and Last Position, resulting in the fastest possible TTFF in either hot or warm start modes.

During Backup State, the I/O block is powered off. The suggestion is that the host forces its outputs to a low state or to a high-Z state during the Backup State to minimize small leakage currents (<10 μ A typically) at receiver's input signals.

1.13 Jamming Remover

The Jamming Remover is an embedded HW block providing interference suppression that tracks and removes up to 12 pieces CW (Carrier Wave) type signals up to -80 dBm (total power signal levels). By default the interference suppression is disabled and usage requires a PMTK command to enable it.

 For more information concerning jamming remover configuration command, see the *MAX-M5Q Receiver Description including Protocol Specification* [1].

The Jamming Remover can be used for solving narrow band (CW) EMI problems in the customer's system. For example, it is effective against narrow band clock harmonics. When enabled, Jammer Remover will increase current drain by about 1 mA, and impact on GNSS performance is low at modest jamming levels. However, at high jammer levels of -90 to -80 dBm, the RF signal sampling (ADC) starts to get saturated after which the GNSS signal levels start to reduce.

 The Jamming Remover is not effective against wide band noise (e.g. from a host CPU memory bus), which cannot be separated from thermal noise floor. A wide band jamming signal increases the effective noise floor and eventually reduces GNSS signal levels.

1.14 Antenna

1.14.1 Antenna input

The antenna input provides simultaneous reception of all frequencies from 1560 to 1606 MHz. The module supports only active antennas. The antenna input RF_IN impedance is 50 Ω . The RF input signal path contains a SAW band-pass filter before the internal LNA, which provides good out-of-band protection against GNSS blocking caused by possible nearby wireless transmitters.

 Antenna input is ESD sensitive. An external TVS diode with low capacitance (<0.5 pF, e.g. Infineon ESD0P2RF) can be used to improve RF-input ESD capability.

1.14.2 Active GNSS antenna

The customer has to use an external active GNSS antenna. It is suggested the active antenna has a net gain including cable loss, as specified in Table 3. Specified sensitivity is measured with external low noise (NF \leq 1 dB, G \geq 15 dB) amplifier.

When the module is in Standby/Backup mode, the antenna bias can be switched off externally by using the ANT_ON signal output to switch off bias supply.

Parameter	Specification	
Antenna Type		Active antenna
Active Antenna Recommendations	Minimum gain	15 dB (including cable loss)
	Maximum gain	30 dB
	Maximum noise figure	1.5 dB

Table 3: Antenna Specifications for MAX-M5Q modules

1.14.3 Active antenna control (ANT_ON)

The ANT_ON pin can be used to turn on and off an external LNA or an active antenna. This reduces power consumption in Power Save modes.

2 Pin definition

2.1 Pin assignment

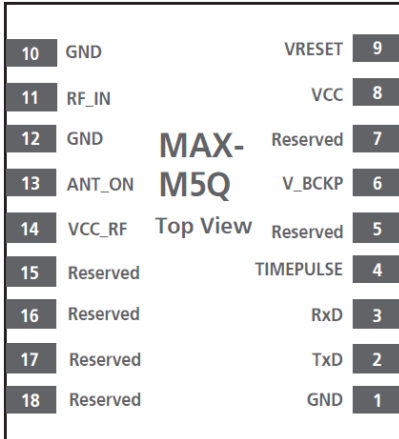

Figure 4: Pin Assignment of MAX-M5Q

No	Name	I/O	Description
1	GND		Ground
2	TXD	O	Serial Port
3	RXD	I	Serial Port
4	TIMEPULSE	O	Time pulse (1PPS)
5	Reserved		Reserved
6	V_BCKP		Backup voltage supply
7	Reserved		Note: connect VCC_IO for MAX-7 and future migration
8	VCC		Supply voltage
9	VRESET	I	RESET_N
10	GND		Ground
11	RF_IN	I	GPS signal input
12	GND		Ground
13	ANT_ON	O	Antenna control
14	VCC_RF		Output Voltage RF section
15	Reserved	-	Reserved
16	Reserved	-	Reserved
17	Reserved	-	Reserved
18	Reserved	-	Reserved

Table 4: Pinout for MAX-M5Q



Pins designated Reserved should not be used (except Pin 7). For more information about Pinouts see the *MAX-M5Q Hardware Integration Manual* [2].

3 Configuration management

Configuration settings can be modified with PMTK configuration messages. The modified settings remain stored in battery-backup RAM. The modified configuration will be retained, as long as the backup battery supply is not interrupted.



For more information about configuration management, see the *MAX-M5Q Receiver Description including Protocol Specification* [1].

4 Electrical specification



The limiting values given are in accordance with the Absolute Maximum Rating System (IEC 134). Stress above one or more of the limiting values may cause permanent damage to the device. These are stress ratings only, and operation of the device at these or at any other conditions above those given in the Characteristics sections of the specification is not implied. Exposure to these limits for extended periods may affect device reliability.



Where application information is given, it is advisory only and does not form part of the specification. For more information see the *MAX-M5Q Hardware Integration Manual* [2].

4.1 Absolute maximum rating

Parameter	Symbol	Condition	Min	Max	Units
Power dissipation	P_{DS}		-	200	mW
Power supply voltage	VCC		-0.3	+4.3	V
Backup battery voltage	V_BCKP		-0.3	+4.3	V
Input pin voltage	V _{in}		-0.5	3.6	V
DC current through any digital I/O pin (except supplies)	I _{pin}			10	mA
VCC_RF output current	ICC_RF			100	mA
Input power at RF_IN	Pr _{fin}	in band 1575 +/- 10 MHz		-40	dBm
		out of band <1460 MHz or >1710 MHz		+15	dBm
IO ESD voltage	V _{io} (ESD)	only RF_IN, Machine Model	-50	+50	V
		excluding RF_IN, HBM Model	-1000	+1000	V
Storage temperature	T _{stg}		-40	+85	°C

Table 5: Absolute maximum ratings of MAX-M5Q



Stressing the device beyond the “Absolute Maximum Ratings” may cause permanent damage. These are stress ratings only. The product is not protected against overvoltage or reversed voltages. If necessary, voltage spikes exceeding the power supply voltage specification, given in table above, must be limited to values within the specified boundaries by using appropriate protection diodes.

4.2 Operating conditions



All specifications are at an ambient temperature of 25°C. Extreme operating temperatures can significantly impact specification values. Applications operating near the temperature limits should be tested to ensure the specification.

Parameter	Symbol	Min	Typ	Max	Units	Condition
Power supply voltage	VCC	+3.0	+3.3	+3.6	V	
Backup battery voltage	V_BCKP	+2.0	+3.0	+3.6	V	
Backup battery current	I_BCKP		10		μA	V_BCKP = 3.0 V VCC = 0 V
Input pin voltage range	V _{in}	-0.3		+3.6	V	
Digital IO Pin Low level input voltage	V _{il}	-0.3		+0.7	V	
Digital IO Pin High level input voltage	V _{ih}	+2.1		+3.6	V	
Digital IO Pin Low level output voltage	V _{ol}	-0.3		0.4	V	I _{oh} = 2 mA
Digital IO Pin High level output voltage	V _{oh}	+2.4	+2.8	+3.1	V	I _{oh} = 2 mA
VCC_RF voltage	VCC_RF		VCC-0.1		V	
VCC_RF output current	ICC_RF			100 ⁵	mA	
Receiver Chain Noise Figure	NF _{tot}		5		dB	
Operating temperature	Topr	-40	+25	+85	°C	

Table 6: Operating conditions

 Operation beyond the specified operating conditions can affect device reliability.

4.3 Indicative power requirements

Table 7 lists examples of the total system supply current for a possible application.

 Values in Table 7 are provided for customer information only, as an example of typical power requirements. Values are characterized on samples; actual power requirements can vary depending on FW version used, external circuitry, number of SVs tracked, signal strength, type of start as well as time, duration and conditions of test.

Parameter	Symbol	Min	Typ	Max	Units
Max. supply current ⁶	I _{ccp}		32		mA
	I _{cc} Tracking (Continuous mode)		17		mA
Average supply current ^{7, 8}	I_BCKP Tracking (Continuous mode)		40		μA
	I_BCKP Tracking (peak)		60		μA

Table 7: Indicative power requirements at VCC and V_BCKP 3.0 V

 For more information about power requirements, see the *MAX-M5Q Hardware Integration Manual* [2]

⁵ Current must be limited externally.

⁶ Use this figure to dimension maximum current capability of power supply. Measurement of this parameter with 1 Hz bandwidth.

⁷ Use this figure to determine required battery capacity.

⁸ Simulated constellation of 8 satellites is used. All signals are at -130 dBm.

5 Mechanical specifications

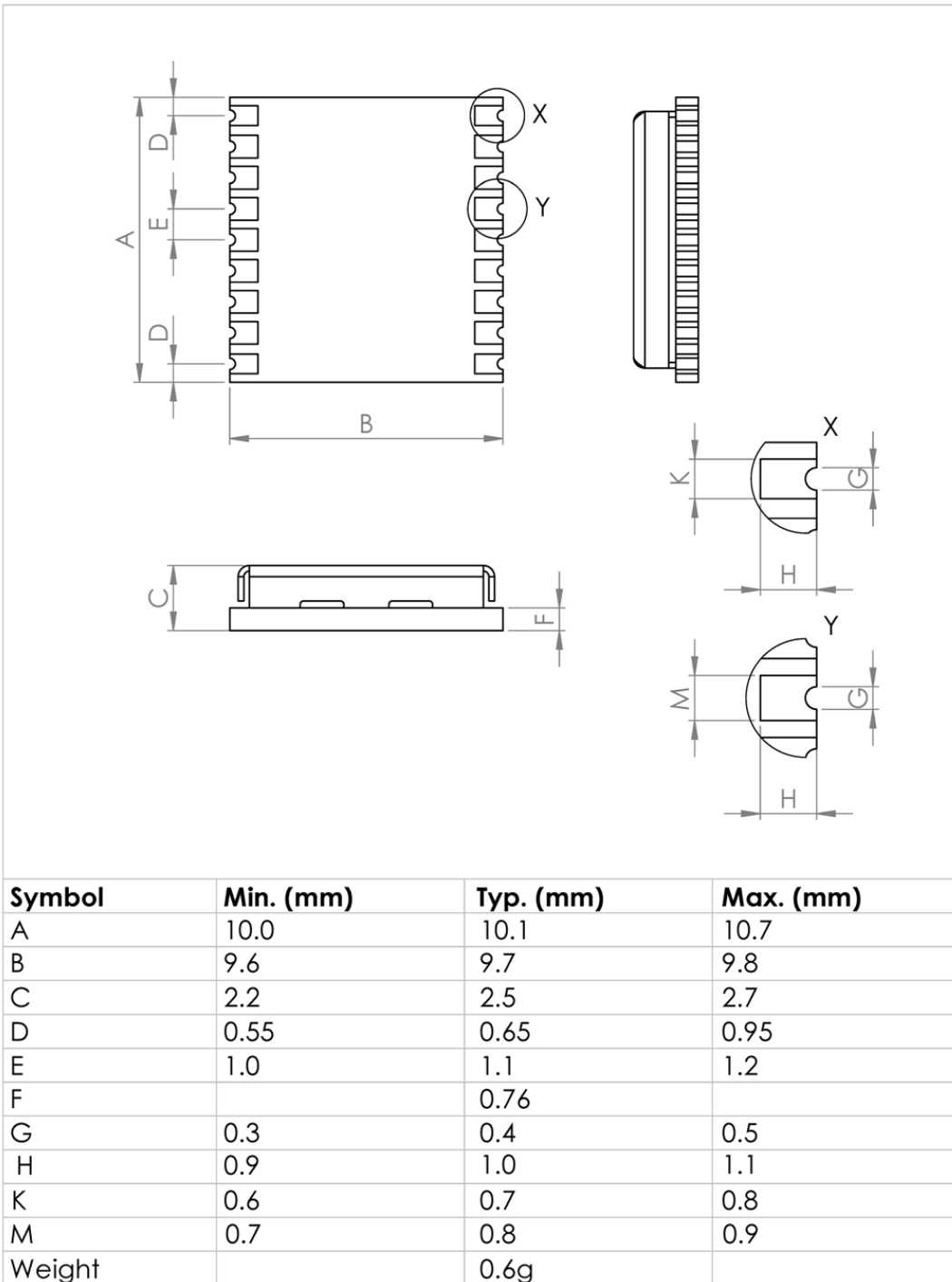

Figure 5: Dimensions



For information regarding the paste mask and footprint, see the *MAX-M5Q Hardware Integration Manual* [2].

6 Reliability tests and approvals

6.1 Reliability tests

 MAX-M5Q modules are based on MT3333 GNSS chips.

Tests for product qualifications are according to ISO 16750 "Road vehicles – Environmental conditions and testing for electrical and electronic equipment", and appropriate standards.

 This is the target standard for MAX-M5Q receivers. Revised and supplementary data will be published later.

6.2 Approvals



Products marked with this lead-free symbol on the product label comply with the "Directive 2002/95/EC of the European Parliament and the Council on the Restriction of Use of certain Hazardous Substances in Electrical and Electronic Equipment" (RoHS).

u-blox MAX-M5Q GNSS modules are RoHS compliant.

7 Product handling & soldering

7.1 Packaging

MAX-M5Q modules are delivered as hermetically sealed, reeled tapes in order to enable efficient production, production lot set-up and tear-down. For more information see the *u-blox Package Information Guide* [3].

7.1.1 Reels

MAX-M5Q GNSS modules are deliverable in quantities of 500 pcs on a reel. MAX-M5Q modules are shipped on Reel Type B, as specified in the *u-blox Package Information Guide* [3].

7.1.2 Tapes

Figure 6 shows the position and orientation of MAX-M5Q modules as they are delivered on tape. The dimensions of the tapes are specified in Figure 7.

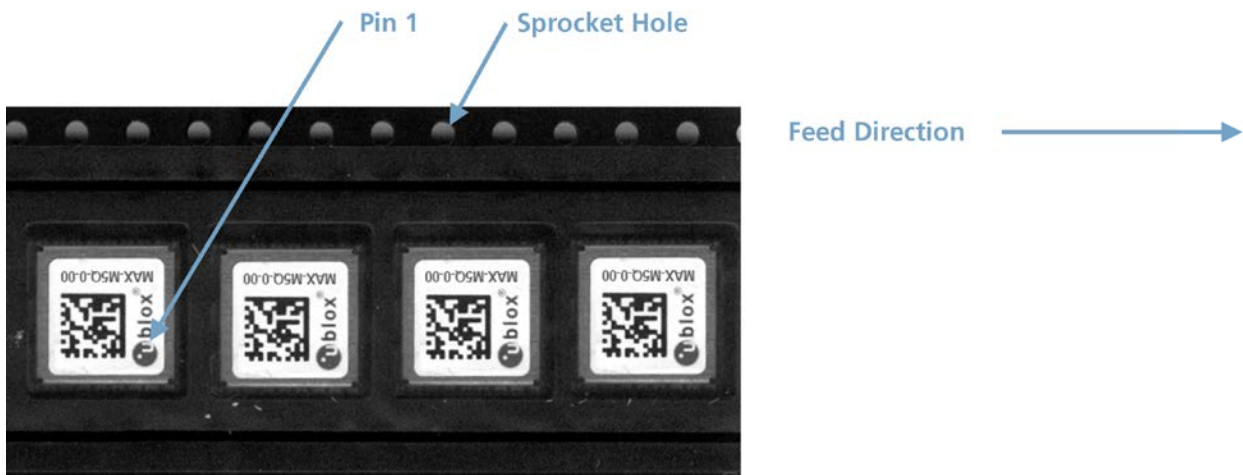

Figure 6: Tape and module orientation

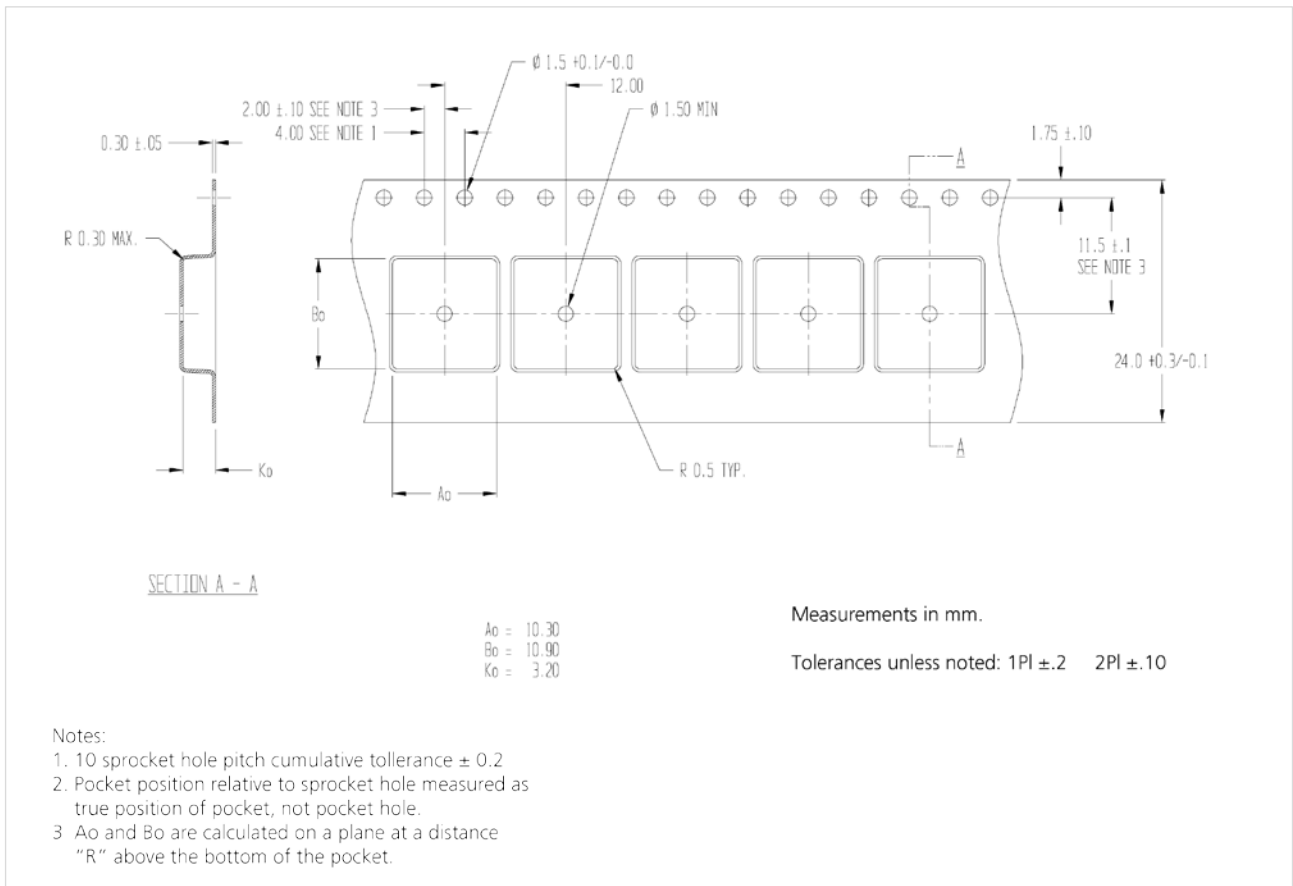

Figure 7: MAX-M5Q Tape dimensions

7.2 Shipment, storage and handling

For important information regarding shipment, storage and handling, see the *u-blox Package Information Guide* [3].

7.2.1 Moisture Sensitivity Levels

The Moisture Sensitivity Level (MSL) relates to the packaging and handling precautions required. MAX-M5Q modules are rated at MSL level 4.



For MSL standard see IPC/JEDEC J-STD-020. Download available at www.jedec.org.



For more information regarding MSL, see the *u-blox Package Information Guide* [3].

7.2.2 Reflow soldering

Reflow profiles are to be selected according u-blox recommendations (see *MAX-M5Q Hardware Integration Manual* [2]).

7.2.3 ESD handling precautions



MAX-M5Q modules are Electrostatic Sensitive Devices (ESD). Observe handling precautions! Failure to observe these precautions can result in severe damage to the GNSS receiver!

GNSS receivers are Electrostatic Sensitive Devices (ESD) and require special precautions when handling. Exercise care when handling patch antennas, due to the risk of electrostatic charges. In addition to standard ESD safety practices, take the following measures into account whenever handling the receiver:

- Unless there is a galvanic coupling between the local GND (i.e. the work table) and the PCB GND, then the first point of contact when handling the PCB must always be between the local GND and PCB GND.
- Before mounting an antenna patch, connect ground of the device
- When handling the RF pin, do not come into contact with any charged capacitors and be careful when contacting materials that can develop charges (e.g. patch antenna ~10 pF, coax cable ~50-80 pF/m, soldering iron)
- To prevent electrostatic discharge through the RF input, do not touch any exposed antenna area. If there is any risk that such exposed antenna area is touched in non ESD protected work area, implement proper ESD protection measures in the design.
- When soldering RF connectors and patch antennas to the receiver's RF pin, make sure to use an ESD safe soldering iron (tip).



8 Default messages

Interface	Settings
UART Output	115,200 Baud, 8 bits, no parity bit, 1 stop bit NMEA protocol: GGA, GLL, GSA, GSV, RMC and VTG messages (default) PMTK messages
UART Input	115,200 Baud, 8 bits, no parity bit, 1 stop bit PMTK commands
TIMEPULSE (1Hz Nav)	1 pulse per second, synchronized at rising edge, pulse length 100 ms

Table 8: Default messages



Refer to the *MAX-M5Q Receiver Description including Protocol Specification* [1] for information about further settings.

9 Labeling and ordering information

9.1 Product labeling

The labeling of u-blox MAX-M5Q GNSS modules includes important product information. The location of the product type number is shown in Figure 8.

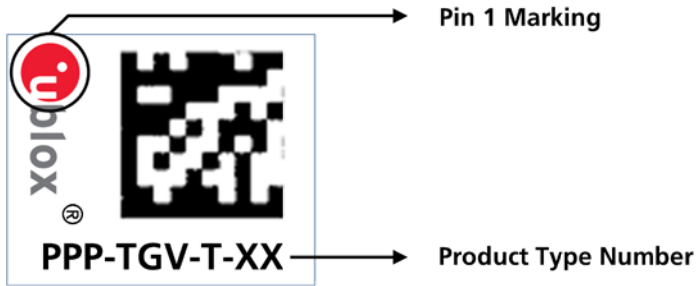

Figure 8: Location of product type number on MAX-M5Q module label

9.2 Explanation of codes

Three different product code formats are used. The **Product Name** is used in documentation such as this data sheet and identifies all u-blox products, independent of packaging and quality grade. The **Ordering Code** includes options and quality, while the **Type Number** includes the hardware and firmware versions. Table 9 details these three different formats:

Format	Structure
Product Name	PPP-TGV
Ordering Code	PPP-TGV-T
Type Number	PPP-TGV-T-XX

Table 9: Product Code Formats

The parts of the product code are explained in Table 10.

Code	Meaning	Example
PPP	Product Family	MAX
TG	Platform (Technology and Generation)	M5 = Multi-GNSS, Fastrax IT530M based
V	Variant	Function set (A-Z)
T	Grade or functional element	Describes standardized functional element or quality grade 0 = Default variant, A= automotive
XX	Product Detail	Describes product details or options such as hard- and software revision, cable length, etc.

Table 10: Part identification code

9.3 Ordering codes

10 Ordering No.	11 Product
MAX-M5Q-0	GNSS LCC Module, 3.0–3.6 V, TCXO, Active Antenna Supply, 9.7 x 10.1 mm, 500 pcs/reel

Table 11: Product ordering codes for standard grade modules



Product changes affecting form, fit or function are documented by u-blox. For a list of Product Change Notifications (PCNs), see our website.

Related documents

- [1] MAX-M5Q Receiver Description including Protocol Specification, Docu. No. UBX-13002496
- [2] MAX-M5Q Hardware Integration Manual, Docu. No. UBX-13002460
- [3] u-blox Package Information Guide, Docu. No. GPS-X-11004



For regular updates to u-blox documentation and to receive product change notifications, register on our homepage.

Revision history

Revision	Date	Name	Status / Comments
-	19-Apr-2013	julu	Objective Specification
1	24-Jun-2013	julu	Update FW info, reduce VCC and V_BCKP to 3.6V max, SBAS enable by default, update module type number and labeling.
A	02-Sep-2013	julu	Advance Information. Changed to UBX document number. Last revision with old document number FTX-HW-13003.
R04	24-Sep-2013	julu	Early Production Information, Revised subtitle, aligned product features table.

Contact

For complete contact information visit us at www.u-blox.com

u-blox Offices

North, Central and South America

u-blox America, Inc.

Phone: +1 703 483 3180
E-mail: info_us@u-blox.com

Regional Office West Coast:

Phone: +1 408 573 3640
E-mail: info_us@u-blox.com

Technical Support:

Phone: +1 703 483 3185
E-mail: support_us@u-blox.com

Headquarters Europe, Middle East, Africa

u-blox AG

Phone: +41 44 722 74 44
E-mail: info@u-blox.com
Support: support@u-blox.com

Asia, Australia, Pacific

u-blox Singapore Pte. Ltd.

Phone: +65 6734 3811
E-mail: info_ap@u-blox.com
Support: support_ap@u-blox.com

Regional Office Australia:

Phone: +61 2 8448 2016
E-mail: info_au@u-blox.com
Support: support_ap@u-blox.com

Regional Office China (Beijing):

Phone: +86 10 68 133 545
E-mail: info_cn@u-blox.com
Support: support_cn@u-blox.com

Regional Office China (Shenzhen):

Phone: +86 755 8627 1083
E-mail: info_cn@u-blox.com
Support: support_cn@u-blox.com

Regional Office India:

Phone: +91 959 1302 450
E-mail: info_in@u-blox.com
Support: support_in@u-blox.com

Regional Office Japan:

Phone: +81 3 5775 3850
E-mail: info_jp@u-blox.com
Support: support_jp@u-blox.com

Regional Office Korea:

Phone: +82 2 542 0861
E-mail: info_kr@u-blox.com
Support: support_kr@u-blox.com

Regional Office Taiwan:

Phone: +886 2 2657 1090
E-mail: info_tw@u-blox.com
Support: support_tw@u-blox.com