



SARA-N2 series

Power-optimized NB-IoT (LTE Cat NB1) modules

Data Sheet



Abstract

Technical data sheet describing SARA-N2 Narrowband Internet of Things cellular modules. These modules are a complete and cost efficient solution offering single-band data transmission for the Internet of Things technology in a compact form factor.

Document Information

Title	SARA-N2 series	
Subtitle	Power-optimized NB-IoT (LTE Cat NB1) modules	
Document type	Data Sheet	
Document number	UBX-15025564	
Revision and date	R15	27-Aug-2018
Disclosure restriction		

Product Status	Corresponding content status	
Functional Sample	Draft	For functional testing. Revised and supplementary data will be published later.
In Development / Prototype	Objective Specification	Target values. Revised and supplementary data will be published later.
Engineering Sample	Advance Information	Data based on early testing. Revised and supplementary data will be published later.
Initial Production	Early Prod. Information	Data from product verification. Revised and supplementary data may be published later.
Mass Production / End of Life	Production Information	Final product specification.

This document applies to the following products:

Name	Type number	Modem version	Application version	PCN reference	Product status
SARA-N200	SARA-N200-02B-00	06.57	A07.03	UBX-18005015	End of Life
	SARA-N200-02B-01	06.57	A09.06	UBX-18048558	Initial Production
SARA-N201	SARA-N201-02B-00	06.57	A07.03	UBX-18005015	End of Life
	SARA-N201-02B-01	06.57	A08.05	UBX-18023224	Initial Production
SARA-N210	SARA-N210-02B-00	06.57	A07.03	UBX-18005015	End of Life
	SARA-N210-02B-01	06.57	A09.06	UBX-18048558	Initial Production
SARA-N211	SARA-N211-02X-00	06.57	A07.03	UBX-18005015	End of Life
	SARA-N211-02X-01	06.57	A09.06	UBX-18048558	Initial Production
SARA-N280	SARA-N280-02B-00	06.57	A07.03	UBX-18005015	End of Life
	SARA-N280-02B-01	06.57	A09.06	UBX-18048558	Initial Production

u-blox or third parties may hold intellectual property rights in the products, names, logos and designs included in this document. Copying, reproduction, modification or disclosure to third parties of this document or any part thereof is only permitted with the express written permission of u-blox.

The information contained herein is provided "as is" and u-blox assumes no liability for its use. No warranty, either express or implied, is given, including but not limited to, with respect to the accuracy, correctness, reliability and fitness for a particular purpose of the information. This document may be revised by u-blox at any time without notice. For the most recent documents, visit www.u-blox.com.

Copyright © u-blox AG.

Contents

Document Information	2
Contents	3
1 Functional description	5
1.1 Overview.....	5
1.2 Product features	5
1.3 Block diagram	6
1.4 Product description	6
1.5 AT command support	7
1.6 Supported features	7
2 Interfaces	8
2.1 Power management	8
2.1.1 Module supply input (VCC)	8
2.1.2 Digital I/O interfaces supply output (V_INT)	8
2.2 Antenna.....	8
2.2.1 Antenna RF interface (ANT).....	8
2.3 System functions.....	8
2.3.1 Module power-on	8
2.3.2 Module power-off.....	8
2.3.3 Module reset	8
2.4 SIM interface.....	9
2.5 Serial interfaces	9
2.5.1 Asynchronous serial interface (UART).....	9
2.5.2 Secondary asynchronous serial interface (Secondary UART)	9
2.5.3 DDC (I ² C) interface.....	10
2.6 GPIO	10
3 Pin definition	11
3.1 Pin assignment.....	11
4 Electrical specification	14
4.1 Absolute maximum rating.....	14
4.1.1 Maximum ESD.....	14
4.2 Operating conditions.....	15
4.2.1 Operating temperature range.....	15
4.2.2 Supply/power pins	15
4.2.3 Current consumption.....	16
4.2.4 RF characteristics	16
4.2.5 RESET_N pin.....	16
4.2.6 SIM interface pins.....	17
4.2.7 UART interface pins	17
4.2.8 Generic Digital Interface pins	17
5 Mechanical specifications	18
6 Qualification and approvals	19
6.1 Reliability tests.....	19

6.2 Approvals.....	19
6.2.1 ATEX certification	20
7 Product handling.....	21
7.1 Packaging	21
7.1.1 Reels	21
7.1.2 Tapes.....	22
7.2 Moisture Sensitivity Levels.....	23
7.3 Reflow soldering	23
7.4 ESD precautions.....	23
8 Labeling and ordering information	24
8.1 Product labeling.....	24
8.2 Explanation of codes	25
8.3 Ordering codes.....	25
Appendix	26
Related documents	28
Revision history	29
Contact.....	30

1 Functional description

1.1 Overview

SARA-N2 series series modules are a Narrow Band Internet of Things (NB-IoT) solution coming in the miniature SARA LGA form factor (16.0 x 26.0 mm, 96-pin). The modules offer IoT data communication over an extended operating temperature range of -40 °C to +85 °C, with extremely low power consumption.

The SARA-N2 series series includes variants supporting single-band and dual-band communication and designed to operate in the frequency range of the LTE bands 5, 8, 20 and 28. These products are ideally suited to battery-powered IoT applications characterized by occasional communications of small amounts of data.

SARA-N2 series modules are the optimal choice for IoT devices designed to operate in locations with a very limited coverage and requiring low energy consumption to permit a very long operating life of the primary batteries. Examples of applications include and are not limited to: smart grids, smart metering, telematics, street lighting, environmental monitoring and control, security and asset tracking.

1.2 Product features

Model	Region	Bands	Positioning	Interfaces	Features	Grade
		3GPP Release Baseline 3GPP Category NB-IoT bands	GNSS via modem AssistNow Software CellLocate®	UART USB 2.0 SPI DDC (I ² C) GPIO	Antenna supervisor Power Save Mode eDRX Deep sleep mode Embedded UDP stack CoAP FW update over AT (FOAT) FW update over the air (FOTA)	Standard Professional Automotive
SARA-N200	Europe APAC	13 NB1 8		2 •	• • • • • • •	•
SARA-N201	APAC	13 NB1 5		2 •	• • • • • • •	•
SARA-N210	Europe	13 NB1 20		2 •	• • • • • • •	•
SARA-N211	Europe	13 NB1 8,20		2 •	• • • • • • •	•
SARA-N280	South America APAC	13 NB1 28		2 •	• • • • • • •	•

Table 1: SARA-N2 series series main features summary

1.3 Block diagram

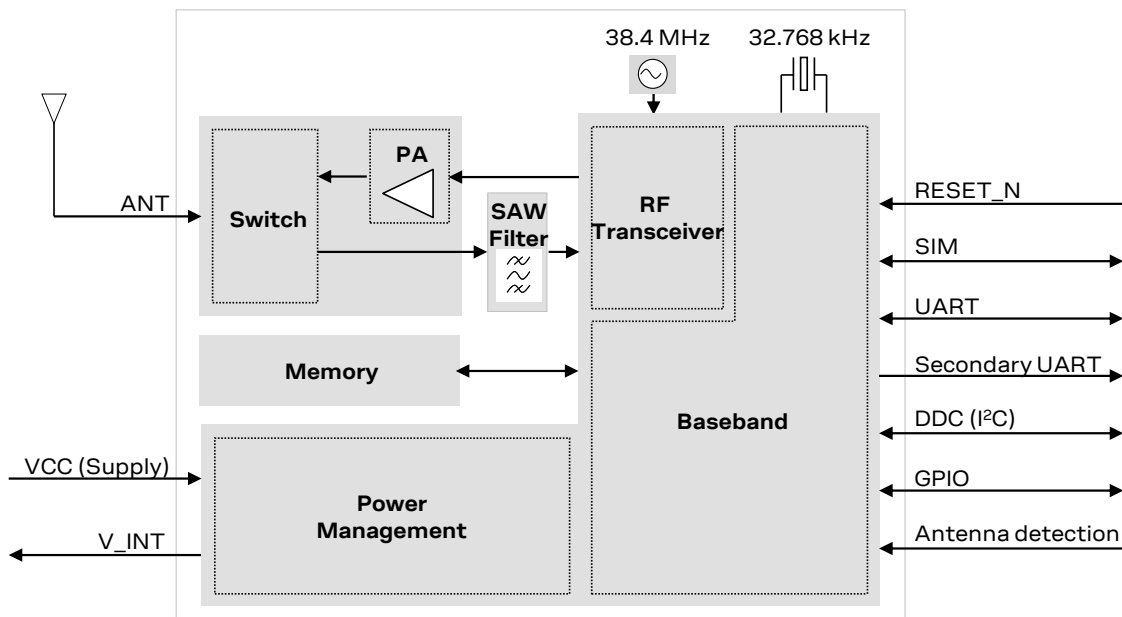

Figure 1: SARA-N2 series series block diagram

The “02” product versions of SARA-N2 series modules do not support the following interfaces, which should not be driven by external devices:

- DDC (I²C) interface
- GPIO2 pin
- Antenna detection interface

1.4 Product description

Item	SARA-N200	SARA-N201	SARA-N210	SARA-N211	SARA-N280
NB-IoT protocol stack	3GPP Release 13	3GPP Release 13	3GPP Release 13	3GPP Release 13	3GPP Release 13
Operating band	Band 8	Band 5	Band 20	Band 8 Band 20	Band 28
Deployment modes	In-Band Guard-Band Standalone	In-Band Guard-Band Standalone	In-Band Guard-Band Standalone	In-Band Guard-Band Standalone	In-Band Guard-Band Standalone
Power Class	Class 3 (23 dBm)	Class 3 (23 dBm)	Class 3 (23 dBm)	Class 3 (23 dBm)	Class 3 (23 dBm)
Data rate	LTE category NB1: Up to 31.25 kb/s UL Up to 27.2 kb/s DL	LTE category NB1: Up to 31.25 kb/s UL Up to 27.2 kb/s DL	LTE category NB1: Up to 31.25 kb/s UL Up to 27.2 kb/s DL	LTE category NB1: Up to 31.25 kb/s UL Up to 27.2 kb/s DL	LTE category NB1: Up to 31.25 kb/s UL Up to 27.2 kb/s DL

Table 2: SARA-N2 series series NB-IoT characteristics summary

1.5 AT command support

The SARA-N2 series modules support AT commands according to the 3GPP standards, plus the u-blox AT command extensions.



For the complete list of all supported AT commands and their syntax, see the SARA-N2 series series AT Commands Manual [\[1\]](#).

1.6 Supported features

Feature	Description
Network Indication	Pin configured to indicate the network status: registered home network, registered roaming, data call enabled, no service. The feature can be enabled through the +UGPIOC AT command.
Embedded UDP stack	Embedded UDP/IP stack for UDP sockets.to establish a transparent end-to-end communication.
CoAP	The Constrained Application Protocol (CoAP) is a datagram-based client/server application protocol for devices on the constrained network (e.g. low overhead, low-power), designed to easily translate to HTTP for simplified integration with the web. CoAP clients can use the GET, PUT, POST and DELETE methods using requests and responses with a CoAP server.
Release Assistance	The Release Assistance feature introduced in 3GPP Rel.13 allows the module to request for the RRC connection to be dropped as soon as the message has been received by the network. This feature allows a reduction in the module power consumption.
Self-Registration	Support of Self-Registration feature according to CTCC (China Telecom Corporation) and CUCC (China Unicom Corporation) requirements.
Firmware update Over AT commands (FOAT)	Firmware module update over AT command interface. The feature can be enabled and configured through the +UFWUPD AT command.
Firmware update Over The Air (FOTA)	The Firmware over-the-air (FOTA) component uses the CoAP context to download a FW update package from a dedicated server.
Power Saving Mode (PSM)	The Power Saving Mode (PSM) feature, defined in 3GPP Rel.13, allows further reduction of the module current consumption maximizing the amount of time a device can remain in extremely low power deep sleep mode during periods of data inactivity. It can be activated and configured by the +CPSMS AT command.
Deep-sleep mode	The SARA-N2 series modules enters in extremely low power deep sleep mode whenever possible, using the internal 32 kHz clock to maintaining an extremely low current consumption. This optimizes the life time of the battery pack used to supply the system
eDRX	Extended mode DRX, based on 3GPP Rel.13, reduces the amount of signaling overhead decreasing the frequency of scheduled measurements and/or transmissions performed by the module. This in turn leads to a reduction in the module power consumption while maintaining a perpetual connection with the base station
Coverage Enhancement	Coverage Enhancements Modes introduced in 3GPP Rel.13 for the NB-IoT system improve the cell signal penetration allowing a 20 dB coverage enhancement over standard GSM systems.

Table 3: Some of the main features supported by SARA-N2 series modules

2 Interfaces

2.1 Power management

2.1.1 Module supply input (VCC)

SARA-N2 series modules must be supplied through the **VCC** pins by a DC power supply with nominal voltage of 3.6 V. Voltage must be stable during module operation, taking into account that the current drawn from **VCC** pins may vary significantly based on the power consumption profile of the NB-IoT system.

2.1.2 Digital I/O interfaces supply output (V_INT)

SARA-N2 series modules provide an internally generated supply rail output (**V_INT**) operating at 1.8 V. This can be used in place of an external discrete regulator to supply external digital interfaces.

The voltage level present at the **V_INT** pin depends on the module operating mode:

- When the radio is off, the voltage level is kept low (i.e. 0 V)
- When the radio is on, the voltage level is maintained high (i.e. 1.8 V)

 Provide a test point connected to the **V_INT** pin for diagnostic purpose.

2.2 Antenna

2.2.1 Antenna RF interface (ANT)

The **ANT** pin has an impedance of 50 Ω and provides the RF antenna interface of SARA-N2 series modules.

2.2.1.1 Antenna detection (ANT_DET)

The **ANT_DET** pin is an Analog to Digital Converter (ADC) input used to sense the antenna presence evaluating the resistance from the **ANT** pin to GND by means of an external antenna detection circuit implemented on the application board.

 The antenna detection (**ANT_DET**) interface is not supported by "02" product versions.

2.3 System functions

2.3.1 Module power-on

SARA-N2 series modules can be switched on by a rising edge voltage applied to the **VCC** pins. See section 4.2.2 for more details about the valid supply voltage range.

2.3.2 Module power-off

An abrupt under-voltage shutdown occurs on SARA-N2 series modules when the **VCC** supply voltage drops below the operating range minimum limit (see section 4.2.2).

2.3.3 Module reset

SARA-N2 series modules can be reset applying a low voltage level on the **RESET_N** input pin, which is normally set high by an internal pull-up, for a valid time period (see the section 4.2.5). This causes an “external” or “hardware” reset of the module.

 Provide a test point connected to the **RESET_N** pin for diagnostic purposes.

2.4 SIM interface

A SIM card interface is provided by the **VSIM**, **SIM_IO**, **SIM_CLK**, and **SIM_RST** pins of SARA-N2 series modules, supporting 1.8 V SIM card/chip types.

2.5 Serial interfaces

2.5.1 Asynchronous serial interface (UART)

The UART interface is a 5-wire unbalanced asynchronous serial interface available for communication with an application host processor (AT commands and data communication) and for FW upgrade.

The main characteristics of the interface are the following:

- Serial port with RS-232 functionality working at the **VCC** voltage domain (0 V for low data bit or ON state and ~3.6 V, i.e. **VCC**, for high data bit or OFF state)
- Data lines (**RXD** as module data output, **TXD** as module data input)
- Hardware flow control lines (**CTS** as module output, **RTS** as module input)
- The following baud rates are supported: 4800, 9600 (default baud rate), 57600 and 115200 b/s.
- Fixed frame format: 8N1 (8 data bits, no parity, 1 stop bit)

The **CTS** line can be configured as RING indicator, to signal an incoming message received by the module or an URC event, or as Network status indicator (for more details see section 2.6 and the u-blox SARA-N2 Series AT Commands Manual [1], +URING, +UGPIOC AT commands).

 For FW upgrade purposes, connect a test point to the **RXD** and **TXD** pins.

 Hardware flow control function is not supported by the "02" product versions.

2.5.2 Secondary asynchronous serial interface (Secondary UART)

The secondary UART interface is a 2-wire unbalanced asynchronous serial interface available for diagnostic purpose, to capture trace diagnostic logs delivered by the module.

The main characteristics of the interface are:

- Serial port with RS-232 functionality working at the **V_INT** voltage domain (0 V for low data bit or ON state and 1.8 V, i.e. **V_INT**, for high data bit or OFF state)
- Data line (**GPIO1** as module data output)
- No flow control
- Fixed baud rate: 921600 b/s
- Fixed frame format: 8N1 (8 data bits, no parity, 1 stop bit)

 For diagnostic purposes, connect a test point to the **GPIO1** pin.

 The trace diagnostic log is temporarily stopped when the module is in deep-sleep mode.

2.5.3 DDC (I²C) interface

DDC interface: I²C compatible interface available on the **SCL** and **SDA** pins of the module for the communication with external chips and sensors. The interface provides master mode bi-directional bus communication at a bit-rate up to 100 kb/s. The I²C interface requires external pull-up resistors. The internal power domain used by the DDC (I²C) pins is **V_INT** (1.8 V).

 The DDC (I²C) interface is not supported by "02" product versions.

2.6 GPIO

SARA-N2 series series modules provide the following pins:

- **GPIO1** pin, working at the **V_INT** (1.8 V) voltage domain, supporting the Secondary UART data output functionality (see section 2.5.2 and Table 4)
- **GPIO2** pin, working at the **V_INT** (1.8 V) voltage domain, not supported by "02" product versions
- **CTS** pin, working at the **VCC** (3.6 V typical) voltage domain, supporting the Network status indication and the RING indicator functionality (see section 2.5.1 and Table 4)

For more details about how the pins can be configured, see u-blox SARA-N2 Series AT Commands Manual [1], +UGPIOC, +URING AT commands.

 For diagnostic purposes, connect a test point to the **GPIO1** pin.

Function	Description	Default GPIO	Configurable GPIOs
Network status indication	Network status: registered home network, registered roaming, data transmission, no service	--	CTS
RING indicator	Indicates an incoming message received by the module or an URC event	--	CTS
Secondary UART	Secondary UART data output for diagnostic purpose, to capture diagnostic logs delivered by the module	GPIO1	GPIO1
Pin disabled	Tri-state with an internal active pull-down enabled	CTS	CTS

Table 4: GPIO custom functions configuration

3 Pin definition

3.1 Pin assignment

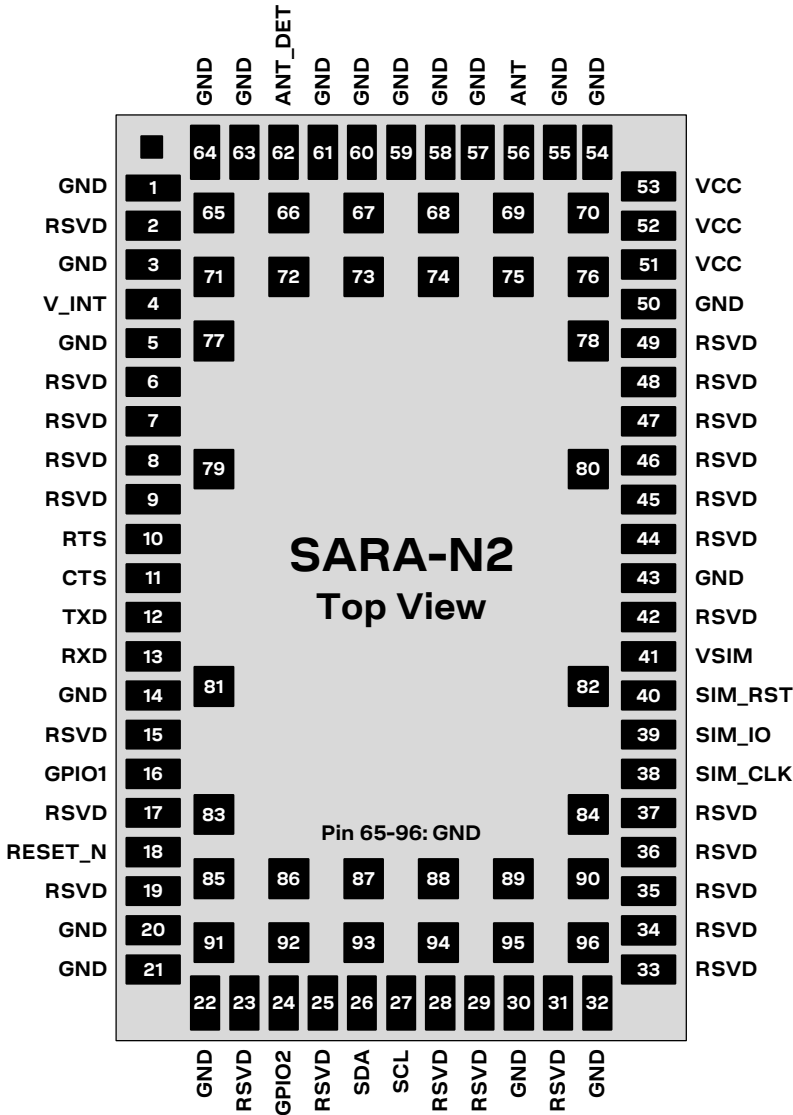

Figure 2: SARA-N2 series series modules pin assignment





No	Name	Power domain	I/O	Description	Remarks
1	GND	GND	N/A	Ground	All GND pads must be connected to ground.
2	RSVD	-	N/A	RESERVED pin	Leave unconnected.
3	GND	GND	N/A	Ground	All GND pads must be connected to ground.
4	V_INT	-	O	Digital I/O Interfaces supply output	V_INT = 1.8 V (typical) supply output generated by the module when the radio is on. See section 4.2.2 for detailed electrical characteristics. For diagnostic purposes, connect a test point to this pin.
5	GND	GND	N/A	Ground	All GND pads must be connected to ground.
6	RSVD	-	N/A	RESERVED pin	Leave unconnected.
7	RSVD	-	N/A	RESERVED pin	Leave unconnected.
8	RSVD	-	N/A	RESERVED pin	Leave unconnected.
9	RSVD	-	N/A	RESERVED pin	Leave unconnected.
10	RTS	UART	I	UART ready to send	HW flow control not supported by '02' product versions. See section 4.2.7 for detailed electrical characteristics.
11	CTS	UART	O	UART clear to send	HW flow control not supported by '02' product versions. The pin can be configured as described in section 2.6. See section 4.2.7 for detailed electrical characteristics.
12	TXD	UART	I	UART data input	See section 4.2.7 for detailed electrical characteristics.
13	RXD	UART	O	UART data output	See section 4.2.7 for detailed electrical characteristics.
14	GND	GND	N/A	Ground	All GND pads must be connected to ground.
15	RSVD	-	N/A	RESERVED pin	Leave unconnected.
16	GPIO1	GDI	I/O	GPIO	Secondary UART data output. See section 4.2.8 for detailed electrical characteristics. For diagnostic purposes, connect a test point to this pin.
17	RSVD	-	N/A	RESERVED pin	Leave unconnected.
18	RESET_N	ERS	I	External reset input	See section 4.2.5 for detailed electrical characteristics. For diagnostic purposes, connect a test point to this pin.
19	RSVD	-	N/A	RESERVED pin	Leave unconnected.
20	GND	GND	N/A	Ground	All GND pads must be connected to ground.
21	GND	GND	N/A	Ground	All GND pads must be connected to ground.
22	GND	GND	N/A	Ground	All GND pads must be connected to ground.
23	RSVD	-	N/A	RESERVED pin	Leave unconnected.
24	GPIO2	GDI	I/O	GPIO	GPIO2 function not supported by '02' product versions. See section 4.2.8 for detailed electrical characteristics.
25	RSVD	-	N/A	RESERVED pin	Leave unconnected.
26	SDA	GDI	I/O	I2C bus data line	I ² C interface not supported by '02' product versions. No internal pull-up. See section 4.2.8 for detailed electrical characteristics.
27	SCL	GDI	O	I2C bus clock line	I ² C interface not supported by '02' product versions. No internal pull-up. See section 4.2.8 for detailed electrical characteristics.
28	RSVD	-	N/A	RESERVED pin	Leave unconnected.
29	RSVD	-	N/A	RESERVED pin	Leave unconnected.
30	GND	GND	N/A	Ground	All GND pads must be connected to ground.
31	RSVD	-	N/A	RESERVED pin	Leave unconnected. For diagnostic purposes, connect a test point to this pin.
32	GND	GND	N/A	Ground	All GND pads must be connected to ground.
33	RSVD	-	N/A	RESERVED pin	This pin can be connected to GND.
34	RSVD	-	N/A	RESERVED pin	Leave unconnected.
35	RSVD	-	N/A	RESERVED pin	Leave unconnected.
36	RSVD	-	N/A	RESERVED pin	Leave unconnected.
37	RSVD	-	N/A	RESERVED pin	Leave unconnected.
38	SIM_CLK	SIM	O	SIM clock	See section 4.2.6 for detailed electrical specs.
39	SIM_IO	SIM	I/O	SIM data	See section 4.2.6 for detailed electrical specs.
40	SIM_RST	SIM	O	SIM reset	See section 4.2.6 for detailed electrical specs.

No	Name	Power domain	I/O	Description	Remarks
41	VSIM	-	O	SIM supply output	VSIM = 1.80 V typical generated by the module. See section 4.2.2 for detailed electrical characteristics.
42	RSVD	-	N/A	RESERVED pin	Leave unconnected.
43	GND	GND	N/A	Ground	All GND pads must be connected to ground.
44	RSVD	-	N/A	RESERVED pin	Leave unconnected.
45	RSVD	-	N/A	RESERVED pin	Leave unconnected.
46	RSVD	-	N/A	RESERVED pin	Leave unconnected.
47	RSVD	-	N/A	RESERVED pin	Leave unconnected.
48	RSVD	-	N/A	RESERVED pin	Leave unconnected.
49	RSVD	-	N/A	RESERVED pin	Leave unconnected.
50	GND	GND	N/A	Ground	All GND pads must be connected to ground.
51	VCC	VCC	I	Module supply input	All VCC pins must be connected to external supply. See 4.2.2 and 4.2.3 for detailed electrical characteristics.
52	VCC	VCC	I	Module supply input	All VCC pins must be connected to external supply. See 4.2.2 and 4.2.3 for detailed electrical characteristics.
53	VCC	VCC	I	Module supply input	All VCC pins must be connected to external supply. See 4.2.2 and 4.2.3 for detailed electrical characteristics.
54	GND	GND	N/A	Ground	All GND pads must be connected to ground.
55	GND	GND	N/A	Ground	All GND pads must be connected to ground.
56	ANT	ANT	I/O	RF antenna	50 Ω nominal characteristic impedance. See section 4.2.4 for detailed RF characteristics.
57	GND	GND	N/A	Ground	All GND pads must be connected to ground.
58	GND	GND	N/A	Ground	All GND pads must be connected to ground.
59	GND	GND	N/A	Ground	All GND pads must be connected to ground.
60	GND	GND	N/A	Ground	All GND pads must be connected to ground.
61	GND	GND	N/A	Ground	All GND pads must be connected to ground.
62	ANT_DET	ADC	I	Antenna detection	ANT_DET not supported by '02' product versions.
63	GND	GND	N/A	Ground	All GND pads must be connected to ground.
64	GND	GND	N/A	Ground	All GND pads must be connected to ground.
65-96	GND	GND	N/A	Ground	All GND pads must be connected to ground.

Table 5: SARA-N2 series series modules pin-out

For an explanation of abbreviations and terms used, see Appendix A.

4 Electrical specification

-  Stressing the device above one or more of the ratings listed in the Absolute Maximum Rating section may cause permanent damage. These are stress ratings only. Operating the module at these or at any conditions other than those specified in the Operating Conditions section (section 4.2) of the specification should be avoided. Exposure to Absolute Maximum Rating conditions for extended periods may affect device reliability.
-  Operating condition ranges define those limits within which the functionality of the device is guaranteed.
-  Electrical characteristics are defined according to the verification on a representative number of samples or according to the simulation.
-  Where application information is given, it is advisory only and does not form part of the specification.

4.1 Absolute maximum rating

-  Limiting values given below are in accordance with the Absolute Maximum Rating System (IEC 134).

Symbol	Description	Condition	Min.	Max.	Unit
VCC	Module supply voltage	Input DC voltage at VCC pin		4.25	V
GDI	Generic digital interfaces	Input DC voltage at Generic digital interfaces pins		2.1	V
SIM	SIM interface	Input DC voltage at SIM interface pins		2.1	V
UART	UART interface	Input DC voltage at UART interface pins		4.25	V
ERS	External reset signal	Input DC voltage at RESET_N pin		4.25	V
Rho_ANT	Antenna ruggedness	Output RF load mismatch ruggedness at ANT pins		10:1	VSWR
Tstg	Storage temperature		-40	85	°C

Table 6: Absolute maximum ratings

-  The product is not protected against overvoltage or reversed voltages. If necessary, voltage spikes exceeding the power supply voltage specification given in table above must be limited to values within the specified boundaries by using appropriate protection devices.

4.1.1 Maximum ESD

Parameter	Min	Typical	Max	Unit	Remarks
ESD sensitivity for all pins			1000	V	Human Body Model according to JESD22-A114

Table 7: Maximum ESD ratings

-  u-blox cellular modules are Electrostatic Sensitive Devices and require special precautions when handling. See section 7.4 for ESD handling instructions.

4.2 Operating conditions

- Unless otherwise indicated, all operating condition specifications are at an ambient temperature of +25 °C.
- Operation beyond the operating conditions is not recommended and extended exposure beyond them may affect device reliability.

4.2.1 Operating temperature range

Parameter	Min.	Typical	Max.	Unit	Remarks
Operating temperature range	-40		+85	°C	
	-20		+85	°C	Normal operating temperature range
	-40		-20	°C	Extended operating temperature range

Table 8: Environmental conditions

4.2.1.1 Normal operating temperature range

The module is fully functional and meets the 3GPP specification across the specified temperature range.

4.2.1.2 Extended operating temperature range

The module is fully functional across the specified temperature range. Occasional deviations from the 3GPP specification may occur.

4.2.2 Supply/power pins

Pin Name	Parameter	Min	Typ	Max	Unit
VCC	Module supply normal operating input voltage ¹	3.10	3.60	4.00	V
	Module supply extended operating input voltage ²	2.75		4.20	V

Table 9: Input characteristics of Supply/Power pins

Pin Name	Parameter	Min	Typ	Max	Unit
VSIM	SIM supply output voltage		1.80		V
V_INT	Generic Digital Interfaces supply output voltage		1.80		V
I_INT	Generic Digital Interfaces supply output current capability			80	mA

Table 10: Output characteristics of Supply/Power pins

¹ Input voltage at **VCC** pins must be above the normal operating range minimum limit to switch-on the module.

² Occasional deviations from the 3GPP specifications may occur. The RF power transmitted by the module may be few dB lower than expected when operating below the minimum value of the normal operating range. Ensure that input voltage at **VCC** never drops below the extended operating range minimum limit during module operation to avoid possible module switch-off events.

4.2.3 Current consumption

Mode	Band	Condition	Tx power	Min	Typ ³	Max	Unit
Deep-sleep mode	-	Averaged current over a 10-second period			3		μA
Active mode	-	Averaged current over a 10-second period			6		mA
Rx-mode	All	Averaged current over a 10-second period			46		mA
Tx-mode	All	Averaged current over a 2-second period	-40 dBm		74		mA
			-7 dBm		75		mA
			3 dBm		78		mA
			13 dBm		100		mA
			23 dBm		220		mA

Table 11: VCC current consumption⁴

4.2.4 RF characteristics

Parameter		Min	Max	Unit	Remarks
Frequency range Band 5	Uplink	824	849	MHz	Module transmit
	Downlink	869	894	MHz	Module receive
Frequency range Band 8	Uplink	880	915	MHz	Module transmit
	Downlink	925	960	MHz	Module receive
Frequency range Band 20	Uplink	832	862	MHz	Module transmit
	Downlink	791	821	MHz	Module receive
Frequency range Band 28	Uplink	703	748	MHz	Module transmit
	Downlink	758	803	MHz	Module receive

Table 12: Operating RF frequency bands

Parameter	Min.	Typical	Max.	Unit	Remarks
Maximum output power		23.0		dBm	Uplink BPSK/QPSK modulation

Condition: 50 Ω output load

Table 13: Transmitter maximum output power

Parameter	Min.	Typical	Max.	Unit	Remarks
Receiver input sensitivity		-135		dBm	Downlink RF level @ BLER MCS-1 < 10 %

Table 14: Receiver sensitivity performance

4.2.5 RESET_N pin

Parameter	Min.	Typical	Max.	Unit	Remarks
Internal supply for External Reset Input Signal		VCC		V	Module supply input (VCC)
Schmitt Trigger Low to High Threshold Point (V_{T+})		0.52*VCC		V	
Schmitt Trigger High to Low Threshold Point (V_{T-})		0.36*VCC		V	
Pull-up resistance		78		kΩ	Internal active pull-up to VCC
Low-level input current			-10	μA	
RESET_N low-level time	500			ns	Low time to reset the module

Table 15: RESET_N pin characteristics

³ Typical values with a matched antenna.

⁴ Module current consumption through VCC input pins, in the listed modes/conditions.

4.2.6 SIM interface pins

Parameter	Min.	Typ.	Max.	Unit	Remarks
Internal supply for SIM domain		1.8		V	Generic Digital Interface supply output (VSIM)
Low-level input	-0.1*VSIM		0.2*VSIM	V	
High-level input	0.7*VSIM		1.1*VSIM	V	
Low-level output		0.0		V	
High-level output		VSIM		V	
Internal pull-up on SIM_IO		4.7		k Ω	Internal pull-up to VSIM
Clock frequency on SIM_CLK		4.8		MHz	
Input / Output leakage current			± 10	μ A	

Table 16: SIM pins characteristics

4.2.7 UART interface pins

Parameter	Min.	Typ.	Max.	Unit	Remarks
Internal supply for UART domain		VCC		V	Module supply input (VCC)
Low-level input	-0.1*VCC		0.2*VCC	V	
High-level input	0.7*VCC		1.1*VCC	V	
Low-level output		0.0		V	
High-level output		VCC		V	
Input / Output leakage current			± 10	μ A	

Table 17: UART pins characteristics

4.2.8 Generic Digital Interface pins

Parameter	Min.	Typ.	Max.	Unit	Remarks
Internal supply for GDI domain		1.8		V	Generic Digital Interface supply output (V_INT)
Low-level input	-0.1*V_INT		0.2*V_INT	V	
High-level input	0.7*V_INT		1.1*V_INT	V	
Low-level output		0.0		V	
High-level output		V_INT		V	
Input / Output leakage current			± 10	μ A	

Table 18: Generic Digital Interface (GDI) pins characteristics

5 Mechanical specifications

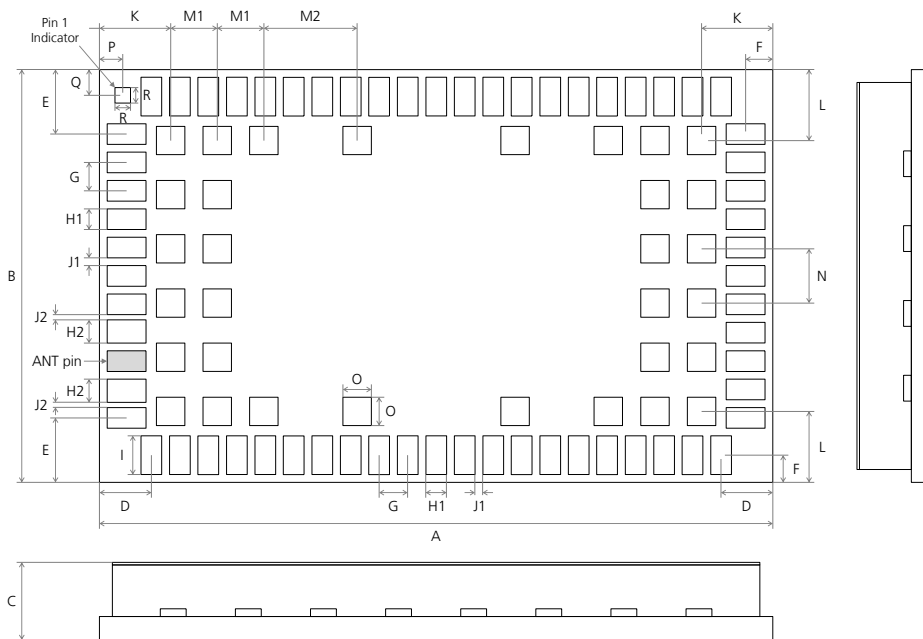

Figure 3: SARA-N2 series series dimensions (bottom and side views)

Parameter	Description	Typical		Tolerance	
A	Module Height [mm]	26.0	(1023.6 mil)	+0.20/-0.20	(+7.9/-7.9 mil)
B	Module Width [mm]	16.0	(629.9 mil)	+0.20/-0.20	(+7.9/-7.9 mil)
C	Module Thickness [mm]	2.4	(94.5 mil)	+0.25/-0.15	(+9.8/-5.9 mil)
D	Horizontal Edge to Lateral Pin Pitch [mm]	2.0	(78.7 mil)	+0.20/-0.20	(+7.9/-7.9 mil)
E	Vertical Edge to Lateral Pin Pitch [mm]	2.5	(98.4 mil)	+0.20/-0.20	(+7.9/-7.9 mil)
F	Edge to Lateral Pin Pitch [mm]	1.05	(41.3 mil)	+0.20/-0.20	(+7.9/-7.9 mil)
G	Lateral Pin to Pin Pitch [mm]	1.1	(43.3 mil)	+0.02/-0.02	(+0.8/-0.8 mil)
H1	Lateral Pin Height [mm]	0.8	(31.5 mil)	+0.02/-0.02	(+0.8/-0.8 mil)
H2	Lateral Pin close to ANT Height [mm]	0.9	(35.4 mil)	+0.02/-0.02	(+0.8/-0.8 mil)
I	Lateral Pin Width [mm]	1.5	(59.1 mil)	+0.02/-0.02	(+0.8/-0.8 mil)
J1	Lateral Pin to Pin Distance [mm]	0.3	(11.8 mil)	+0.02/-0.02	(+0.8/-0.8 mil)
J2	Lateral Pin to Pin close to ANT Distance [mm]	0.2	(7.9 mil)	+0.02/-0.02	(+0.8/-0.8 mil)
K	Horizontal Edge to Central Pin Pitch [mm]	2.75	(108.3 mil)	+0.20/-0.20	(+7.9/-7.9 mil)
L	Vertical Edge to Central Pin Pitch [mm]	2.75	(108.3 mil)	+0.20/-0.20	(+7.9/-7.9 mil)
M1	Central Pin to Pin Horizontal Pitch [mm]	1.8	(70.9 mil)	+0.02/-0.02	(+0.8/-0.8 mil)
M2	Central Pin to Pin Horizontal Pitch [mm]	3.6	(141.7 mil)	+0.02/-0.02	(+0.8/-0.8 mil)
N	Central Pin to Pin Vertical Pitch [mm]	2.1	(82.7 mil)	+0.02/-0.02	(+0.8/-0.8 mil)
O	Central Pin Height and Width [mm]	1.1	(43.3 mil)	+0.02/-0.02	(+0.8/-0.8 mil)
P	Horizontal Edge to Pin 1 Indicator Pitch [mm]	0.9	(35.4 mil)	+0.20/-0.20	(+7.9/-7.9 mil)
Q	Vertical Edge to Pin 1 Indicator Pitch [mm]	1.0	(39.4 mil)	+0.20/-0.20	(+7.9/-7.9 mil)
R	Pin 1 Indicator Height and Width [mm]	0.6	(23.6 mil)	+0.02/-0.02	(+0.8/-0.8 mil)
Weight	Module Weight [g]	< 3			

Table 19: SARA-N2 series series dimensions

- Module Height tolerance may be exceeded close to the corners of the PCB due to the cutting process. In the worst case, the height could be +0.40 mm more than the typical value.
- For information regarding the footprint and paste mask recommended for the application board integrating the cellular module, see SARA-N2 series series System Integration Manual [2].

6 Qualification and approvals

6.1 Reliability tests

Tests for product family qualifications are according to ISO 16750 “Road vehicles – Environmental conditions and testing for electrical and electronic equipment“, and appropriate standards.

6.2 Approvals



Products marked with this lead-free symbol on the product label comply with the “Directive 2002/95/EC of the European Parliament and the Council on the Restriction of Use of certain Hazardous Substances in Electrical and Electronic Equipment“ (RoHS).

SARA-N2 series series modules are RoHS compliant.

No natural rubbers, hygroscopic materials, or materials containing asbestos are employed.

Table 20 lists the main approvals for SARA-N2 series series modules.

Certification Scheme	SARA-N200	SARA-N201	SARA-N210	SARA-N211	SARA-N280
CE (European Conformity)	•		•	•	
GCF (Global Certification Forum)				•	
CCC (China Compulsory Certification)	•	•			
SRRC (State Radio Regulation of China)	•	•			
NCC (National Communications Commission Taiwan)	•			•	•
Anatel (Agência Nacional de Telecomunicações Brazil)					•
RCM (Australia Regulatory Compliance Mark)					•
NBTC (Thailand Regulatory Certification)	•				
IMDA (Singapore Regulatory Certification)	•				
ATEX (Atmosphere Explosive)				•	
China Telecom (Network Operator)		•			
China Unicom (Network Operator)	•				
Deutsche Telecom (Network Operator)	•		•	•	

Table 20: SARA-N2 series series main certification approvals

For all the certificates of compliancy and for the complete list of approvals (including country and network operator approvals) of the SARA-N2 series series modules, see our website (www.u-blox.com) or contact the u-blox office or sales representative nearest you.

6.2.1 ATEX certification

SARA-N211 modules are certified as components intended for use in potentially explosive atmospheres compliant to the following standards:

- IEC 60079-0
- IEC 60079-11
- IEC 60079-26

SARA-N211 modules certification number according to the ATEX directive 2014/34/EU:

- SIQ 18 ATEX 104 U

SARA-N211 modules certification number according to the IECEx conformity assessment system:

- IECEx SIQ 18.0004U

According to the standards listed above, SARA-N211 modules are certified with following marking:

- Ex II 1G, Ex ia IIC

According to the marking stated above, the modules are certified as electrical equipment of:

- group 'II': intended for use in areas with explosive gas atmosphere other than mines susceptible to firedamp
- category '1G': intended for use in zone 0 hazardous areas, in which explosive atmospheres caused by mixtures of air and gases, vapors or mists are present continuously, for long periods or frequently
- level of protection 'ia': intrinsically safe apparatus with very high level of protection, not capable of causing ignition in normal operation and with the application of one countable fault or a combination of any two countable fault plus those non-countable faults which give the most onerous condition
- subdivision 'IIC': intended for use in areas where the nature of the explosive gas atmosphere is considered very dangerous based on the Maximum Experimental Safe Gap or the Minimum Ignition Current ratio of the explosive gas atmosphere in which the equipment may be installed (a typical gas is hydrogen), so that the modules are also suitable for applications intended for use in subdivision IIB (typical gas is ethylene) and subdivision IIA (a typical gas is propane)

Section 4.2.1 defines the temperature range of use for SARA-N211 modules.

The RF radiating profile of SARA-N211 modules is compliant to all the applicable 3GPP / ETSI standards, with a maximum of 250 mW RF average power according to the LTE Cat NB1 Power Class stated in Table 2. Section 8.1 describes the nameplate of SARA-N211 modules (see Figure 7).

Table 21 lists the maximum input and equivalent parameters that must be considered in the sub-division IIC, the sub-division IIB and the sub-division IIA for SARA-N211 modules.

Parameter	SARA-N211
U _i	4.2 V
I _i	0.5 A
C _i	68.1 μF
L _i	8.5 μH

Table 21: Maximum input and equivalent parameters for sub-division IIC, IIB and IIA

 For more information about the integration of these modules in applications intended for use in potentially explosive atmospheres, see the SARA-N2 Series System Integration Manual [2].

7 Product handling

7.1 Packaging

SARA-N2 series series modules are delivered as hermetically sealed, reeled tapes to enable efficient production, production lot set-up and tear-down. For more information about packaging, see the u-blox Package Information Guide [\[3\]](#).



Figure 4: Reeled SARA-N2 series modules

7.1.1 Reels

SARA-N2 series series modules are deliverable in quantities of 250 pieces on a reel. SARA-N2 series series modules are delivered using reel type B2 as described in the u-blox Package Information Guide [\[3\]](#).

Parameter	Specification
Reel type	B2
Delivery quantity	250

Table 22: Reel information for SARA-N2 series series modules

 Quantities of less than 250 pieces are also available. Contact u-blox for more information.

7.1.2 Tapes

Figure 5 specifies the dimensions and orientations of the tapes for SARA-N2 series series module.

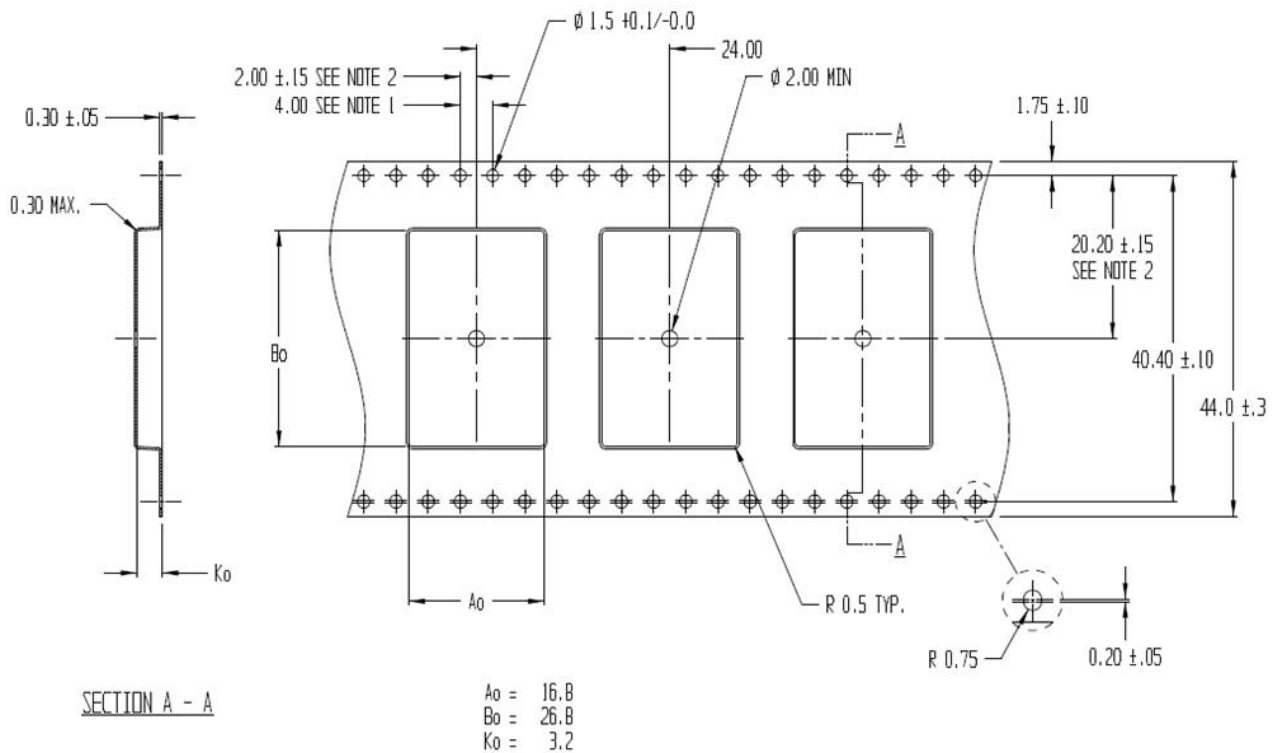



Figure 5: Dimensions for SARA-N2 series series on tape

Parameter	Value
A_0	16.8
B_0	26.8
K_0	3.2

Table 23: SARA-N2 series tape dimensions (mm)

- Note 1: 10 sprocket hole pitch cumulative tolerance ± 0.2 .
- Note 2: Pocket position relative to sprocket hole measured as true position of pocket, not pocket hole.
- Note 3: A_0 and B_0 are calculated on a plane at a distance "R" above the bottom of the pocket.

7.2 Moisture Sensitivity Levels

-  SARA-N2 series modules are Moisture Sensitive Devices (MSD) in accordance to IPC/JEDEC specification

The Moisture Sensitivity Level (MSL) relates to the packaging and handling precautions required. SARA-N2 series modules are rated at MSL level 4. For more information regarding moisture sensitivity levels, labeling, storage and drying, see the u-blox Package Information Guide [3].

-  For the MSL standard, see IPC/JEDEC J-STD-020 (can be downloaded from www.jedec.org).

7.3 Reflow soldering

Reflow profiles are to be selected according to u-blox recommendations (see the SARA-N2 series series System Integration Manual [2]).

-  Failure to observe these recommendations can result in severe damage to the device!

7.4 ESD precautions

-  SARA-N2 series modules contain highly sensitive electronic circuitry and are Electrostatic Sensitive Devices (ESD). Handling SARA-N2 series modules without proper ESD protection may destroy or damage them permanently.

SARA-N2 series modules are Electrostatic Sensitive Devices (ESD) and require special ESD precautions typically applied to ESD sensitive components.

Table 7 reports the maximum ESD ratings of the SARA-N2 series modules.

Proper ESD handling and packaging procedures must be applied throughout the processing, handling and operation of any application that incorporates SARA-N2 series module.

ESD precautions should be implemented on the application board where the module is mounted, as described in the SARA-N2 series series System Integration Manual [2].

-  Failure to observe these recommendations can result in severe damage to the device!

8 Labeling and ordering information

8.1 Product labeling

SARA-N2 series module labels include important product information. [Figure 6](#) illustrates the label of all the SARA-N2 series modules except for SARA-N211 and includes: u-blox logo, production lot, Pb-free marking, product type number, module IMEI number, regulatory certification info, and production country.

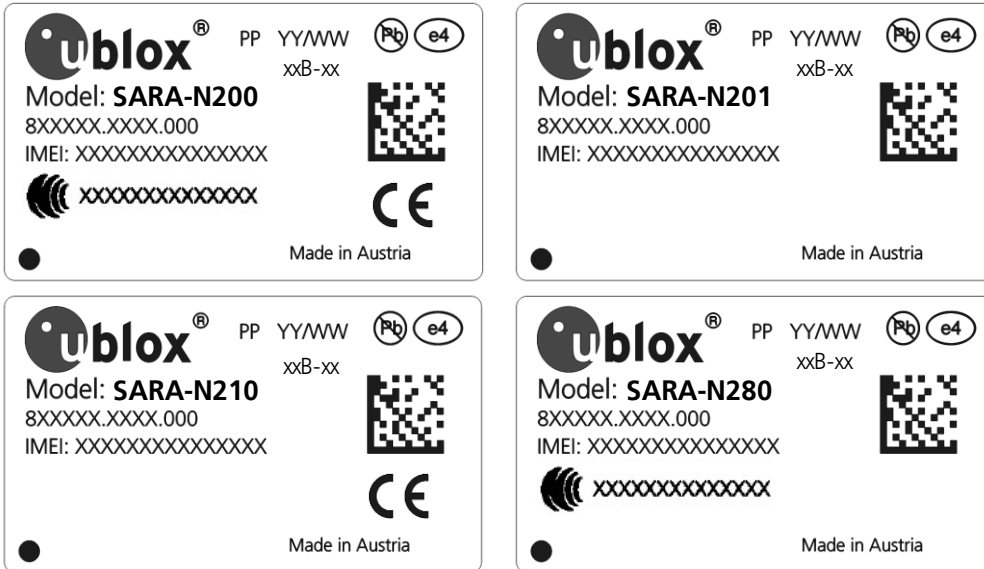

Figure 6 Location of product type number on SARA-N2 series series module label

[Figure 7](#) illustrates the label of SARA-N211 modules and includes: u-blox logo, production lot, Pb-free marking, product type number, IMEI number, ATEX marking with the IECEx and ATEX certificate numbers and category classification.



Figure 7: SARA-N211 module label

8.2 Explanation of codes

Three different product code formats are used. The **Product Name** is used in documentation such as this data sheet and identifies all u-blox products, independent of packaging and quality grade. The **Ordering Code** includes options and quality, while the **Type Number** includes the hardware and firmware versions. [Table 24](#) below details these three different formats:

Format	Structure
Product Name	SARA-TGVV
Ordering Code	SARA-TGVV-MMQ
Type Number	SARA-TGVV-MMQ-XX

Table 24: Product code formats

[Table 25](#) explains the parts of the product code.

Code	Meaning	Example
TG	Platform (Technology and Generation): <ul style="list-style-type: none"> Dominant technology (G: GSM; U: HSUPA; C: CDMA 1xRTT; N: NB-IoT; R: LTE low data rate (Cat 1 and below); L: LTE high data rate (Cat 3 and above)) Generation: 1...9 	N2
VV	Variant function set based on the same platform [00...99]	00
MM	Major product version [00...99]	02
Q	Product grade: <ul style="list-style-type: none"> B = professional A = automotive X = ATEX certified 	B
XX	Minor product version (not relevant for certification)	00

Table 25: Part identification code

8.3 Ordering codes

Ordering No.	Product
SARA-N200-02B	Narrowband IoT module supporting Band 8, mainly designed for operation in Europe / APAC 16.0 x 26.0 x 2.4 mm, 250 pieces/reel
SARA-N201-02B	Narrowband IoT module supporting Band 5, mainly designed for operation in APAC 16.0 x 26.0 x 2.4 mm, 250 pieces/reel
SARA-N210-02B	Narrowband IoT module supporting Band 20, mainly designed for operation in Europe 16.0 x 26.0 x 2.4 mm, 250 pieces/reel
SARA-N211-02X	Narrowband IoT module supporting Band 8 and 20, mainly designed for operation in Europe ATEX certified 16.0 x 26.0 x 2.4 mm, 250 pieces/reel
SARA-N280-02B	Narrowband IoT module supporting Band 28, mainly designed for operation in South America / APAC 16.0 x 26.0 x 2.4 mm, 250 pieces/reel

Table 26: Product ordering codes



Product changes affecting form, fit or function are documented by u-blox. For a list of Product Change Notifications (PCNs), see our website.

Appendix

A Glossary

Abbreviation	Definition
ADC	Analog to Digital Converter
APAC	Asia-Pacific
ATEX	EU Explosive Atmosphere Directive
CDMA	Code-Division Multiple Access
CE	Certification Mark for EHS compliance in the European Economic Area
CLK	Clock
CTS	Clear To Send
DC	Direct Current
DDC	Display Data Channel
DL	Down Link (Reception)
DRX	Discontinuous Reception
ERS	External Reset Input Signal
ESD	Electrostatic Discharge
ETSI	European Telecommunications Standards Institute
FOAT	Firmware (update) Over AT commands
FOTA	Firmware (update) Over-The-Air
FW	Firmware
GDI	Generic Digital Interface
GND	Ground
GNSS	Global Navigation Satellite System
GPIO	General Purpose Input/Output
GSM	Global System for Mobile communications
HSUPA	High Speed Uplink Packet Access
HTTP	HyperText Transfer Protocol
HW	Hardware
I/O	Input/Output
I ² C	Inter-Integrated Circuit
IEC	International Electrotechnical Commission
IMEI	International Mobile Equipment Identity
ISO	International Organization for Standardization
LGA	Land Grid Array
LTE	Long-Term Evolution
MCS	Modulation Coding Scheme
MSD	Moisture Sensitive Device
MSL	Moisture Sensitivity Level
N/A	Not Applicable
PCB	Printed Circuit Board
PCN	Product Change Notification
PSM	Power Saving Mode
RF	Radio Frequency
RRC	Radio Resource Control
RTS	Request To Send

Abbreviation	Definition
SCL	Serial Clock
SDA	Serial Data
SIM	Subscriber Identity Module
SPI	Serial Peripheral Interface
TXD	Transmit Data
UART	Universal Asynchronous Receiver/Transmitter
UDP	User Datagram Protocol
UL	Uplink (Transmission)
URC	Unsolicited Result Code
USB	Universal Serial Bus
VCC	Voltage Collector Collector
VSWR	Voltage Standing Wave Ratio

Table 27: Explanation of the abbreviations and terms used

Related documents

- [1] u-blox SARA-N2 series AT Commands Manual, Doc. No. UBX-16014887
- [2] u-blox SARA-N2 series System Integration Manual, Doc. No. UBX-17005143
- [3] u-blox Package Information Guide, Doc. No. UBX-14001652

 For regular updates to u-blox documentation and to receive product change notifications, register on our homepage (www.u-blox.com).

Revision history

Revision	Date	Name	Status / Comments
R01	09-Dec-2015	sfal	Initial release
R02	23-Feb-2016	sfal	Document aligned with features supported by the first FW delivery. AT command section added
R03	15-Apr-2016	sfal	Document aligned with features supported by FW V100R100C00B100
R04	20-Jun-2016	sfal	Voltage extended operating range values added. AT commands section removed
R05	31-Oct-2016	sfal	Document updated to product version "01"
R06	13-Dec-2016	sfal	Added additional requirements on the secondary UART. Updates on data rates, secondary UART baud rate and supported features.
R07	22-Feb-2017	sfal	Extended document applicability to SARA-N280-01B. Changed UL/DL data rates
R08	24-Mar-2017	sfal	Document applicability extended to product version "02" and SARA-N200-02B. Removed SPI interface (not supported)
R09	22-May-2017	sfal / sses	Document updated for Prototypes of "02" product version
R10	01-Aug-2017	sfal / lpah	Updated disclaimer restriction Updated product status for "01B" product version Updated current consumption in Rx mode
R11	09-Oct-2017	sses	Updated VCC, V_INT, RESET_N and GPIO description Updated main certification approvals
R12	17-Oct-2017	lpah	ES application version updated
R13	22-Feb-2018	lpah / sses	Extended document applicability to SARA-N211-02X and updated product status Updated VCC supply extended operating voltage range Updated Antenna Detection, GPIO, approvals, and labels section
R14	22-Jun-2018	lpah / sses	Extended the document applicability to SARA-N201-02B-01. Updated SARA-N211-02X product status. Added ATEX info, minor corrections and clarifications. Document rebranded.
R15	27-Aug-2018	lpah	Extended the document applicability to SARA-N200-02B-01, SARA-N210-02B-01, SARA-N211-02X-01, SARA-N280-02B-01.

Contact

For complete contact information, visit us at www.u-blox.com.

u-blox Offices

North, Central and South America

u-blox America, Inc.

Phone: +1 703 483 3180
E-mail: info_us@u-blox.com

Regional Office West Coast:

Phone: +1 408 573 3640
E-mail: info_us@u-blox.com

Technical Support:

Phone: +1 703 483 3185
E-mail: support@u-blox.com

Headquarters

Europe, Middle East, Africa

u-blox AG

Phone: +41 44 722 74 44
E-mail: info@u-blox.com
Support: support@u-blox.com

Asia, Australia, Pacific

u-blox Singapore Pte. Ltd.

Phone: +65 6734 3811
E-mail: info_ap@u-blox.com
Support: support_ap@u-blox.com

Regional Office Australia:

Phone: +61 2 8448 2016
E-mail: info_anz@u-blox.com
Support: support_ap@u-blox.com

Regional Office China (Beijing):

Phone: +86 10 68 133 545
E-mail: info_cn@u-blox.com
Support: support_cn@u-blox.com

Regional Office China (Chongqing):

Phone: +86 23 6815 1588
E-mail: info_cn@u-blox.com
Support: support_cn@u-blox.com

Regional Office China (Shanghai):

Phone: +86 21 6090 4832
E-mail: info_cn@u-blox.com
Support: support_cn@u-blox.com

Regional Office China (Shenzhen):

Phone: +86 755 8627 1083
E-mail: info_cn@u-blox.com
Support: support_cn@u-blox.com

Regional Office India:

Phone: +91 80 405 092 00
E-mail: info_in@u-blox.com
Support: support_in@u-blox.com

Regional Office Japan (Osaka):

Phone: +81 6 6941 3660
E-mail: info_jp@u-blox.com
Support: support_jp@u-blox.com

Regional Office Japan (Tokyo):

Phone: +81 3 5775 3850
E-mail: info_jp@u-blox.com
Support: support_jp@u-blox.com

Regional Office Korea:

Phone: +82 2 542 0861
E-mail: info_kr@u-blox.com
Support: support_kr@u-blox.com

Regional Office Taiwan:

Phone: +886 2 2657 1090
E-mail: info_tw@u-blox.com
Support: support_tw@u-blox.com