

RCB-F9T

Differential timing with u-blox RCB-F9T high accuracy timing board

Application note



Abstract

This application note describes how to set up differential timing mode using two RCB-F9Ts in a master-slave configuration.

Document information

Title	RCB-F9T		
Subtitle	Differential timing with u-blox RCB-F9T high accuracy timing board		
Document type	Application note		
Document number	UBX-20011550		
Revision and date	R02	13-May-2021	
Disclosure restriction	C1-Public		

This document applies to the following products:

Product name	Type number	Firmware version	PCN reference
RCB-F9T-0	RCB-F9T-0-01	TIM2.01	N/A
RCB-F9T-1	RCB-F9T-1-00	TIM2.12	N/A

u-blox or third parties may hold intellectual property rights in the products, names, logos and designs included in this document. Copying, reproduction, modification or disclosure to third parties of this document or any part thereof is only permitted with the express written permission of u-blox.

The information contained herein is provided "as is" and u-blox assumes no liability for its use. No warranty, either express or implied, is given, including but not limited to, with respect to the accuracy, correctness, reliability and fitness for a particular purpose of the information. This document may be revised by u-blox at any time without notice. For the most recent documents, visit www.u-blox.com.

Copyright © u-blox AG.

Contents

Document information	2
Contents	3
1 Overview	4
2 Connections	4
2.1 Connecting to a PC	4
2.1.1 RCB-F9T pin assignment	5
2.2 Antenna.....	6
3 Receiver configuration	7
3.1 Master and slave configuration	7
3.2 Master location configuration.....	7
3.2.1 Survey-in.....	7
3.2.2 Fixed position.....	8
3.3 Master UART1 configurations	8
3.3.1 Verifying the master configuration	9
3.4 Slave configuration.....	10
4 Master-to-slave cable connections.....	11
4.1 Verifying slave operation.....	12
Related documentation.....	14
Revision history	14
Contact.....	15

1 Overview

u-blox ZED-F9T and RCB-F9T offer a differential timing mode, where correction data is exchanged with other neighboring receivers via a communication network. In differential timing mode, the receiver can operate either as a master reference station, or as a slave station. The master station provides correction data to the surrounding slave stations, which accurately synchronize to the master's time.

This document shows an example setup of the ZED-F9T module differential timing mode using RCB-F9T boards. It illustrates the following scenario:

- The master receiver sends RTCM 3.3 correction messages to the slave receiver.
- Upon receiving the corrections the slave receiver aligns its time to that of the master.

 Both master and slave must be either an RCB-F9T receiver board or a ZED-F9T receiver. Other receiver modules such as, for example, ZED-F9P, do not work in a differential timing setup.

2 Connections

To enable differential timing the master and slave devices need to be configured. Using a PC with u-center is the most convenient method.

2.1 Connecting to a PC

Only low-voltage serial connections are exposed on the interface. Use for example an FTDI USB-to-UART cable adapter to connect with u-center to enable configuration and control of the RCB-F9T boards.

Figure 1 shows the type of cable necessary. The FTDI TTL-232RG-VREG3V3-WE cable supports +3.3 V based TTL-level UART signals and provides a +3.3 V / 250 mA regulated rated output for providing board power.

 TTL-232RG-VREG3V3-WE from FTDI is a wire ended-cable. Figure 1 shows an example with a connector termination, that is, provision must be made to enable connection to the RCB-F9T signal connector pins.



Figure 1: TTL-232RG-VREG3V3-WE cable

Figure 2 shows the cable signals and the wire colors for the signals on the TTL-232RG generic cables.

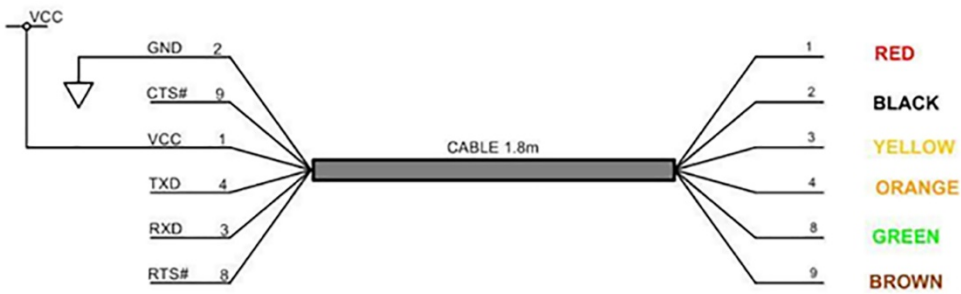

Figure 2: TTL-232RG generic cables connections (numbers refer to pad numbers on the PCB)

For information on connecting the cable wires and RCB-F9T pins, see Table 2.

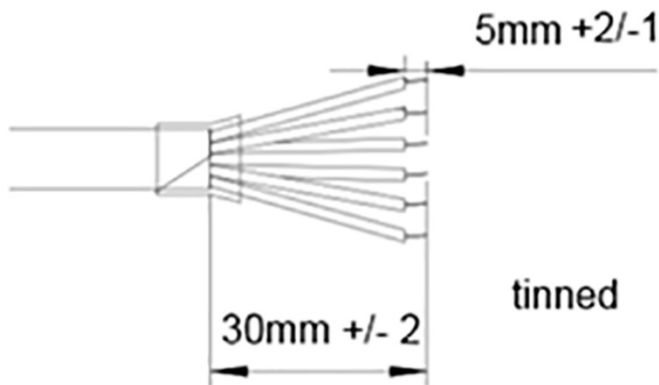

Figure 3: TTL-232RG generic cables mechanical details (dimensions in mm)

For more information on the FTDI cables, see www.ftdichip.com/Products/Cables/USBTTLSerial.htm.

2.1.1 RCB-F9T pin assignment

The board and connector position is shown in Figure 4.

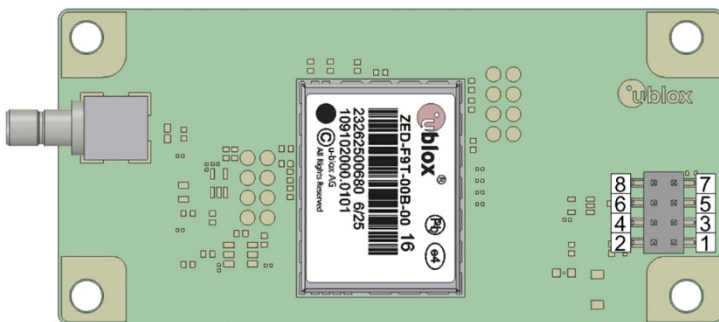

Figure 4: RCB-F9T pin assignment

The pin functionality is depicted in Table 1.

Pin no.	Name	I/O	Description
1	VCC_ANT	I	Antenna power supply, 5.0 V max 100 mA
2	VCC	I	Operating voltage, 3.3 V
3	TXD	O	UART TXD, LVCMOS

4	RST	I	Hardware reset
5	RXD	I	UART RXD, LVCMOS
6	TP1	O	Time pulse1, LVCMOS
7	TP2	O	Time pulse2, LVCMOS
8	GND	-	Ground

Table 1: RCB-F9T pin assignment

Use the FTDI USB serial cable in the following connection scheme to enable operation with a PC.

The two boards must be separately configured for differential timing operation prior to connecting them for testing.

RCB-F9T	USB cable color
Pin 2	Red
Pin 8	Black
Pin 3	Yellow
Pin 5	Orange

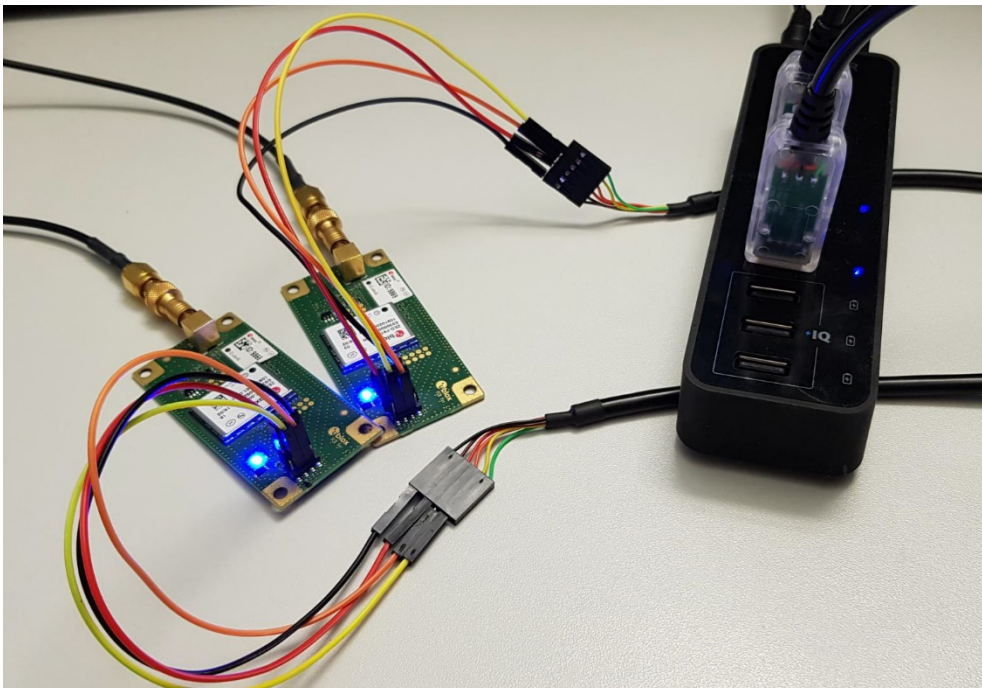
Table 2: Cable connection matrix

Figure 5: Both RCB-F9Ts connected to laptop

2.2 Antenna

In the connections described here, no antenna supply is provided from the RCB-F9T to the antenna. To solve this issue, you can provide a DC supply to RCB-F9T connector pin 1, or use a bias T at the RF connector to supply the antenna.

The ANN-MB (L1/L2) or ANN-MB1(L1/L5) active antenna available from u-blox provides good performance in a convenient form factor for use with the RCB-F9T. It requires a supply voltage from 3.0-5.0 V at typically 15 mA. The product is shown in Figure 6; for more information, consult the product web page at u-blox.com: <https://www.u-blox.com/en/product/ann-mb-series>.



Figure 6: ANN-MB, u-blox multi-band active GNSS antenna

3 Receiver configuration

3.1 Master and slave configuration

Before configuring the boards ensure that u-center is communicating properly. The default baud rate for the boards is 115200.

It is recommended that the following UBX messages are enabled on both the master and slave boards.

- UBX-NAV-PVT
- UBX-NAV-SAT
- UBX-NAV-SIG
- UBX-NAV-STATUS
- UBX-RXM-RTCM

Use the u-center Generation 9 Advanced Configuration View for setting the configuration items detailed later. For more information, see ZED-F9T documentation [3].

3.2 Master location configuration

To use the TIME fix mode, the receiver requires known fixed antenna coordinates. This can be supplied via two methods as described below:

- If the coordinates are not known, the receiver can perform a self-survey of its position.
- If the coordinates are known, they can be entered directly.

3.2.1 Survey-in

Survey-in is a procedure that is carried out prior to entering Time mode. It estimates the receiver position by building a weighted mean of all valid 3D position solutions.

Two major parameters are required when configuring this mode:

- **Minimum observation time**

This defines the minimum observation time independent of the actual number of fixes used for the position estimate.

- **3D position standard deviation**

This defines a limit on the spread of positions that contribute to the calculated mean.

To configure a timing receiver into survey-in mode, the following configuration items are required:

- CFG-TMODE-MODE - set to survey-in
- CFG-TMODE-SVIN_MIN_DUR - survey-in minimum duration

- CFG-TMODE-SVIN_ACC_LIMIT - survey-in position accuracy limit

After setting the mode and completing the termination parameters the survey sequence begins. The survey-in status can be queried using the UBX-TIM-SVIN message. Survey-in ends when both requirements are successfully met.

 Note that the timing receiver should not be fed RTCM corrections while it is in survey-in mode.

3.2.2 Fixed position

Here the timing receiver position coordinates are entered manually. Note that any error in the receiver antenna position coordinates will translate into timing errors.

To enable fixed mode the following configuration items are required:

- CFG-TMODE-MODE receiver mode - set to fixed
- CFG-TMODE-POS_TYPE - determines whether the ARP position is given in ECEF or LAT/LON/HEIGHT

Depending on the position coordinate method the following items are required:

For ECEF:

- CFG-TMODE-ECEF_X ECEF X coordinate of the ARP position
- CFG-TMODE-ECEF_Y ECEF Y coordinate of the ARP position
- CFG-TMODE-ECEF_Z ECEF Z coordinate of the ARP position
- CFG-TMODE-ECEF_X_HP high-precision ECEF X
- CFG-TMODE-ECEF_Y_HP high-precision ECEF Y
- CFG-TMODE-ECEF_Z_HP high-precision ECEF Z

For Lat/Lon/Height:

- CFG-TMODE-LAT latitude of the ARP position
- CFG-TMODE-LAT_HP high-precision latitude of the ARP position
- CFG-TMODE-LON longitude of the ARP position
- CFG-TMODE-LON_HP high-precision longitude of the ARP position
- CFG-TMODE-HEIGHT height of the ARP position
- CFG-TMODE-HEIGHT_HP high-precision height of the ARP position

For both types an accuracy estimate is required:

- CFG-TMODE-FIXED_POS_ACC Fixed position 3D accuracy estimate

3.3 Master UART1 configurations

To use the differential timing mode, you must set the communication protocols carefully. Use u-center to ensure the master serial port is configured for the following speed and protocol settings.

- CFG-UART1-BAUDRATE set to 460800
- CFG-UART1INPROT-UBX set to true
- CFG-UART1INPROT-NMEA set to true
- CFG-UART1OUTPROT-UBX set to false
- CFG-UART1OUTPROT-NMEA set to false
- CFG-UART1OUTPROT-RTCM3X set to true

UART1 will respond to UBX and NMEA input messages but only RTCM3 messages are enabled for output.

To set up the required RTCM3 messages on UART1 send the following configuration items with rate set to 1:

- CFG-MSGOUT-RTCM_3X_TYPE1005_UART1
- CFG-MSGOUT-RTCM_3X_TYPE1077_UART1
- CFG-MSGOUT-RTCM_3X_TYPE1087_UART1
- CFG-MSGOUT-RTCM_3X_TYPE1097_UART1
- CFG-MSGOUT-RTCM_3X_TYPE1127_UART1
- CFG-MSGOUT-RTCM_3X_TYPE1230_UART1
- CFG-MSGOUT-RTCM_3X_TYPE4072_1_UART1

Tip: To save the current configuration, send a CFG-CFG message. This way you will be able to power-cycle the receiver without repeating the above steps.

3.3.1 Verifying the master configuration

After entering the fixed coordinates and configuring the necessary protocols, ensure that the configuration is correct by checking that:

- The master is in TIME mode.

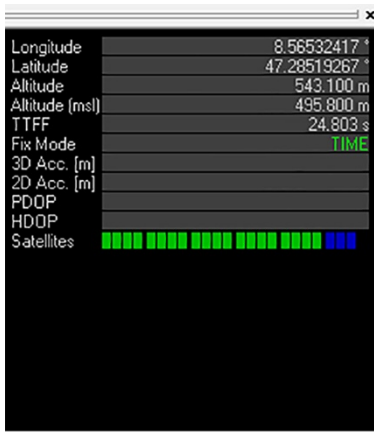

Ensure the NAV-PVT message is enabled to verify the position fix mode is reported on the docking window.

- The packet console shows the configured RTCM messages.

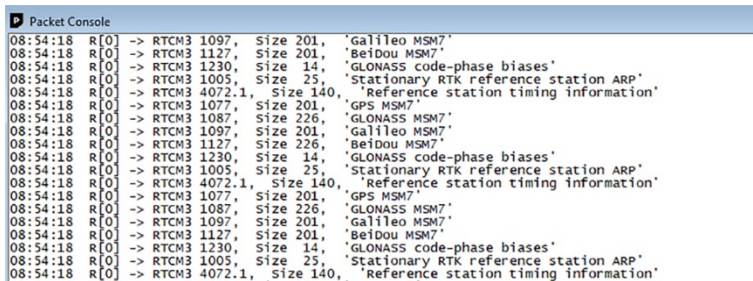

- The “Messages View” shows the configured RTCM messages.

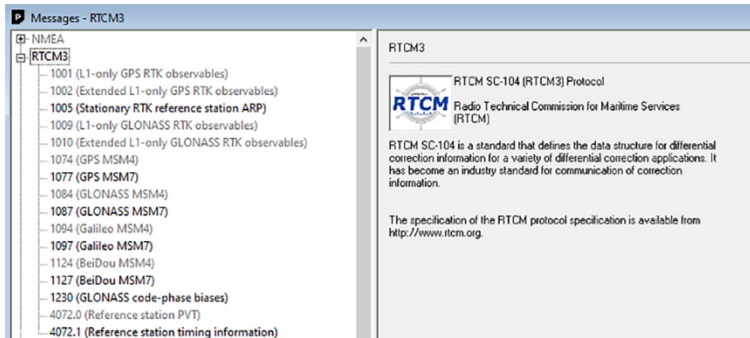

The RTCM 1005 message is only output when the receiver is operating with a TIME fix mode.

3.4 Slave configuration

Prior to operation the slave receiver should be surveyed in similarly to the master. See the instructions in 3.2. The module configuration will receive RTCM 3 messages by default which is necessary to enable differential timing operation. The configuration must also ensure that the slave is able to receive at the transmitted baud rate.

The following configuration is recommended to recognize RTCM messages but also to allow normal NMEA and UBX messages to be used to verify the slave operation.

- CFG-UART1-BAUDRATE set to 460800
- CFG-UART1INPROT-UBX set to true
- CFG-UART1INPROT-NMEA set to true
- CFG-UART1INPROT-RTCM3X set to true
- CFG-UART1OUTPROT-UBX set to true
- CFG-UART1OUTPROT-NMEA set to true

4 Master-to-slave cable connections

Once the configuration has been completed, make the following interconnections to allow corrections from master to slave.

The master UART TXD signal is applied to the slave UART RXD input to receive the RTCM correction messages.

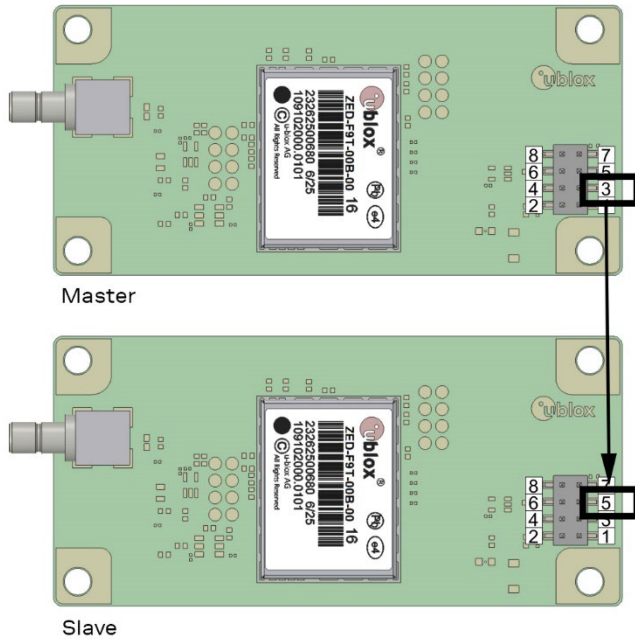

Figure 7: Master to slave cable connection

See Table 1 for RCB-F9T pin assignment.

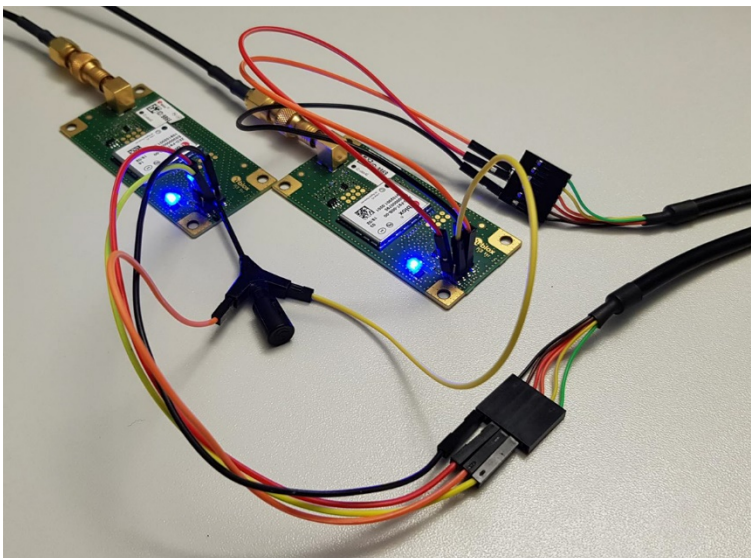

Figure 8: Master to slave cable connection example

Figure 8 shows an example connection setup. In this instance the slave RXD input is shared between the master TXD output and a USB connection to u-center. This provides a route for the correction messages and allows the user to reconfigure the slave if required.

When sending configuration commands or other messages from u-center to the slave unit, disconnect the master output to prevent data collisions.

4.1 Verifying slave operation

To make sure that the slave is using the RTCM corrections, check the following output messages via u-center:

- RXM-RTCM shows the RTCM received messages from the master.

UBX - RXM (Receiver Manager) - RTCM (RTCM input status)

Statistics:

Message Type	Total messages	CRC passed messages	CRC failed messages	(Last) Reference Station ID
1005	557	557	0	0
1077	557	557	0	0
1087	557	557	0	0
1097	557	557	0	0
1127	557	557	0	0
1230	557	557	0	0
4072.1	557	557	0	0

- NAV-SAT shows the use of the pseudo-range differential corrections for each satellite.

UBX - NAV (Navigation) - SIG (Signal Information)

SV	Signal	GLO...	CNO	Residual	PR used	CR used	DO used	Qi	Healthy	Iono. model	Correction source	Corrections used
⊙ G2	L1C/A	-	40	-0.90m	Y	N	Y	7	Y	None	RTCM3 OSR	PR
⊙ G2	L2CM	-	0	0.00m	N	N	N	1	Y	None	None	None
⊙ G5	L1C/A	-	50	0.00m	Y	N	Y	7	Y	None	RTCM3 OSR	PR
⊙ G5	L2CL	-	44	-0.40m	N	N	N	7	Y	None	None	None
⊙ G6	L1C/A	-	0	0.00m	N	N	N	1	?	None	None	None
⊙ G6	L2CM	-	0	0.00m	N	N	N	1	?	None	None	None
⊙ G7	L1C/A	-	50	0.60m	Y	N	Y	7	Y	None	RTCM3 OSR	PR
⊙ G7	L2CL	-	44	0.10m	N	N	N	7	Y	None	None	None
⊙ G9	L1C/A	-	42	0.10m	Y	N	Y	7	Y	None	RTCM3 OSR	PR
⊙ G9	L2CL	-	41	-0.10m	N	N	N	7	Y	None	None	None
⊙ G13	L1C/A	-	44	-1.00m	Y	N	Y	7	Y	None	RTCM3 OSR	PR
⊙ G15	L2CM	-	0	0.00m	N	N	N	1	?	None	None	None
⊙ G21	L1C/A	-	29	0.00m	N	N	N	7	?	None	None	None
⊙ G27	L1C/A	-	29	0.00m	N	N	N	7	?	None	None	None
⊙ G27	L2CL	-	29	0.00m	N	N	N	7	?	None	None	None
⊙ G28	L1C/A	-	40	0.50m	Y	N	Y	7	Y	None	RTCM3 OSR	PR
⊙ G28	L2CM	-	0	0.00m	N	N	N	1	Y	None	None	None
⊙ G30	L1C/A	-	52	0.30m	Y	N	Y	7	Y	None	RTCM3 OSR	PR
⊙ G30	L2CL	-	47	-0.10m	N	N	N	7	Y	None	None	None

- NAV-SIG shows the use of pseudo-range corrections for each signal.

UBX - NAV (Navigation) - SAT (Satellite Information)

SV	CNO	Residual	Nav	Qi	EI	Az	Orbit	Healthy	DGN...	Correction source	Corrections used
⊙ G2	39	-2.80	Y	7	14	228	EPH	Y	Y	RTCM	PR
⊙ G5	50	-0.30	Y	7	64	277	EPH	Y	Y	RTCM	PR
⊙ G7	49	0.20	Y	7	55	59	EPH	Y	Y	RTCM	PR
⊙ G8	0	0.00	N	1	0	66	ALM	Y	N	None	None
⊙ G9	43	-0.40	Y	7	18	95	EPH	Y	Y	RTCM	PR
⊙ G13	45	-1.70	Y	7	34	281	EPH	Y	Y	RTCM	PR
⊙ G15	29	3.20	Y	7	5	285	EPH	Y	N	RTCM	None
⊙ G21	33	0.90	N	7	2	340	EPH	Y	N	None	None
⊙ G27	35	0.00	N	7	2	37	EPH	Y	N	None	None
⊙ G28	41	-1.10	Y	7	21	155	EPH	Y	Y	RTCM	PR
⊙ G30	52	-0.10	Y	7	83	157	EPH	Y	Y	RTCM	PR

For optimal performance, the slave's time pulse configuration (set using UBX-CFG-TP5) should match that of the master. Preferably it is set with an identical GNSS system time or UTC time grid. If a UTC time grid is used, ensure that each is operating with an identical UTC variant and that the corresponding GNSS constellations are enabled to ensure this.

To show that the slave device is applying correction data monitor, the Fix Mode is shown as a DGNSS fix mode, see Figure 9.

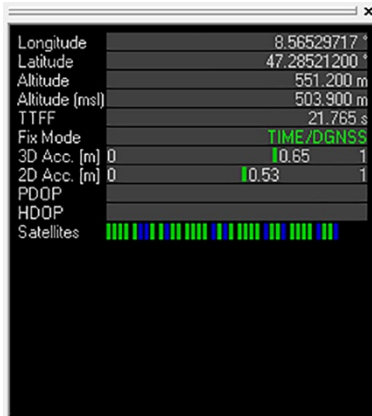



Figure 9: Fix Mode showing DGNSS fix mode

 Enable NAV-PVT message to make sure that the position fix type is plotted on the docking window.

Related documentation

- [1] ZED-F9T Integration manual, [UBX-19005590](#)
- [2] RCB-F9T Integration manual, [UBX-19003747](#)
- [3] ZED-F9T Interface description, [UBX-18053584](#)

 For product change notifications and regular updates of u-blox documentation, register on our website, www.u-blox.com.

Revision history

Revision	Date	Name	Comments
R01	27-Oct-2020	dama	Initial release
R02	13-May-2021	byou	Updated with slave port config, + grammar, typo corrections, legacy configs converted to current style.

Contact

For complete contact information, visit us at www.u-blox.com.

u-blox Offices

North, Central and South America

u-blox America, Inc.

Phone: +1 703 483 3180

Email: info_us@u-blox.com

Regional Office West Coast:

Phone: +1 408 573 3640

Email: info_us@u-blox.com

Technical Support:

Phone: +1 703 483 3185

Email: support@u-blox.com

Headquarters

Europe, Middle East, Africa

u-blox AG

Phone: +41 44 722 74 44

Email: info@u-blox.com

Support: support@u-blox.com

Asia, Australia, Pacific

u-blox Singapore Pte. Ltd.

Phone: +65 6734 3811

Email: info_ap@u-blox.com

Support: support_ap@u-blox.com

Regional Office Australia:

Phone: +61 3 9566 7255

Email: info_anz@u-blox.com

Support: support_ap@u-blox.com

Regional Office China (Beijing):

Phone: +86 10 68 133 545

Email: info_cn@u-blox.com

Support: support_cn@u-blox.com

Regional Office China (Chongqing):

Phone: +86 23 6815 1588

Email: info_cn@u-blox.com

Support: support_cn@u-blox.com

Regional Office China (Shanghai):

Phone: +86 21 6090 4832

Email: info_cn@u-blox.com

Support: support_cn@u-blox.com

Regional Office China (Shenzhen):

Phone: +86 755 8627 1083

Email: info_cn@u-blox.com

Support: support_cn@u-blox.com

Regional Office India:

Phone: +91 80 405 092 00

Email: info_in@u-blox.com

Support: support_in@u-blox.com

Regional Office Japan (Osaka):

Phone: +81 6 6941 3660

Email: info_jp@u-blox.com

Support: support_jp@u-blox.com

Regional Office Japan (Tokyo):

Phone: +81 3 5775 3850

Email: info_jp@u-blox.com

Support: support_jp@u-blox.com

Regional Office Korea:

Phone: +82 2 542 0861

Email: info_kr@u-blox.com

Support: support_kr@u-blox.com

Regional Office Taiwan:

Phone: +886 2 2657 1090

Email: info_tw@u-blox.com

Support: support_tw@u-blox.com